

QuantStudio™ 1 Real-Time PCR System

INSTALLATION, USE, AND MAINTENANCE

Firmware v1.0.x

Publication Number MAN0017853

Revision A.0





Life Technologies Holdings Pte Ltd | Block 33 | Marsiling Industrial Estate Road 3 | #07-06, Singapore 739256

For descriptions of symbols on product labels or product documents, go to thermofisher.com/symbols-definition.

The information in this guide is subject to change without notice.

DISCLAIMER: TO THE EXTENT ALLOWED BY LAW, THERMO FISHER SCIENTIFIC INC. AND/OR ITS AFFILIATE(S) WILL NOT BE LIABLE FOR SPECIAL, INCIDENTAL, INDIRECT, PUNITIVE, MULTIPLE, OR CONSEQUENTIAL DAMAGES IN CONNECTION WITH OR ARISING FROM THIS DOCUMENT, INCLUDING YOUR USE OF IT.

Revision history: Pub. No. MAN0017853 (English)

Revision	Date	Description
A.0	10 October 2018	New document.

Important Licensing Information: These products may be covered by one or more Limited Use Label Licenses. By use of these products, you accept the terms and conditions of all applicable Limited Use Label Licenses.

Trademarks: All trademarks are the property of Thermo Fisher Scientific and its subsidiaries unless otherwise specified. TaqMan is a registered trademark of Roche Molecular Systems, Inc., used under permission and license. Cy is a registered trademark of GE Healthcare. Microsoft and Windows are trademarks of Microsoft Corporation. Pentium is a trademark of Intel Corporation. Google and Chrome are trademarks of Google, Inc.

©2018 Thermo Fisher Scientific Inc. All rights reserved.

Contents

About this guide	8
■ CHAPTER 1 Product information	9
Instrument hardware description	9
Instrument overview	9
Parts of the instrument	11
Parts of the home screen	12
Software description	14
Instrument, desktop, and cloud software features	14
Folders, templates, experiments, and projects	15
Third-party software	16
Supported options for instrument and computer connections	16
Experiment types	18
■ CHAPTER 2 General procedures to operate the instrument	20
Precautions for use	20
Power on the instrument	21
Power off the instrument	21
Sign in	21
Sign out	21
Load and unload a plate in the QuantStudio™ 1 Real-Time PCR Instrument	22
Transfer, view, or manage files and results	23
Transfer EDS files from the instrument home screen	23
View run history and delete or transfer files from the instrument	23
Manage templates (EDT files)	23
■ CHAPTER 3 Configure the instrument and manage instrument profiles	25
Initial start-up	25
Installation and instrument verification	26
Use the instrument without signing in	26
Create an administrator instrument profile during initial start-up	27
Create a new instrument profile	27

Overview of Settings	28
Manage instrument settings	30
Manage the instrument name (Administrator only)	31
Enable Sleep Mode	31
Set the idling temperature for the heated cover	31
Configure the network drive	31
OEM connection only (Administrator only)	31
Select a Cloud region (Administrator only)	32
Set the date and time (Administrator only)	32
Configure the network	32
Restore factory defaults	34
Select a language	34
Learn about the instrument	34
View instrument specifications	34
View and export the License Agreement	35
Manage home screen notifications	35
Manage maintenance, service, and calibrations	35
Update instrument software (Administrator only)	35
Enable remote instrument monitoring (Administrator only)	36
View instrument statistics	36
View instrument logs	36
Manage Users	36
Require instrument profile sign-in (Administrator only)	37
Manage the Sign Out Timer (Administrator only)	37
Manage instrument profiles	37
Link an instrument profile with the Thermo Fisher Cloud	38
Link an existing instrument profile with the Thermo Fisher Cloud	38
Create a new instrument profile and link with the Thermo Fisher Cloud	38
■ CHAPTER 4 Create and run experiments on the instrument	39
Workflow	39
Run an experiment	40
Create and run an experiment from a template	40
Run an experiment from a saved file	40
Repeat the last instrument run	41
Edit an experiment before starting a run	41
Enter or edit template properties	41
Edit the run method	43
Define, assign, and view well details	45

View, pause, or stop a run	46
View real-time data and plots on the instrument touchscreen	46
Adjust the display of real-time plots on the instrument touchscreen	47
Pause or stop an instrument run	47
Lock the touchscreen during a run	47
Transfer EDS files from the instrument home screen	48
■ CHAPTER 5 Calibrate and verify instrument performance	49
Calibration and verification schedule	49
Calibration descriptions	50
View the calibration status and set reminders	51
View calibration status and set reminders in the instrument	51
View calibration status and set reminders in the Cloud	51
Perform ROI/uniformity, background, and dye calibrations	52
Workflow: Calibration	52
Prepare a calibration plate	52
Perform calibrations	53
View calibration images and transfer results to USB	54
Troubleshoot calibration failure	55
Identify contamination	56
Create a background plate <i>(optional)</i>	56
Perform instrument verification using RNase P plates	57
Instrument verification description	57
RNase P instrument verification plate	58
Performance specifications pass criteria	58
Prepare an RNase P plate	58
Perform RNase P verification	59
Troubleshoot verification failure	61
Calibrate custom dyes	62
Custom dyes overview	62
Use a dilution series to determine an optimal custom dye concentration	62
Calibrate the custom dye	65
Calibrate for a custom melt curve experiment	68

- **CHAPTER 6 Maintain the instrument** 70
 - Backup or restore the instrument 70
 - Decontaminate the sample block 71
 - Materials required 71
 - Clean the sample block 71
 - Detailed procedures for cleaning the sample block 73
 - Replace the instrument fuses 73
 - Materials required 73
 - Replace the fuses 74
 - Prepare the instrument to store, move, or ship 74
 - Move the instrument 75
 - Return the instrument for service 75

- **APPENDIX A Install and connect the instrument to a network** 77
 - Workflow: Install and connect to a network 77
 - Before you begin 78
 - Instrument and computer connections 78
 - Unpack and install the instrument 79
 - Power on and follow the startup wizard 80
 - Connect the instrument and the computer directly or to a LAN 80
 - Networking 81
 - Supported options for instrument and computer connections 81
 - Control and monitor networked instruments 82
 - Ethernet port overview 83
 - Firewall ports that must be open 83
 - Networking guidelines and best practices 83

- **APPENDIX B Troubleshooting** 84

- **APPENDIX C Instrument specification and layout** 86
 - Configured system dimensions 87
 - Instrument clearances 88
 - Electrical requirements 88
 - Environmental requirements 89
 - Network requirements 90

■	APPENDIX D	Parts and materials	91
		Kits, consumables, accessories, and reagents	91
		Consumables (96-well, 0.2-mL format)	91
		Accessories	92
		General-use materials and consumables	92
■	APPENDIX E	Safety	93
		Symbols on this instrument	94
		Conformity symbols	95
		Safety alerts on this instrument	96
		Location of safety labels on the instrument	97
		Safety information for instruments not manufactured by Thermo Fisher Scientific	97
		Instrument safety	97
		General	97
		Physical injury	98
		Electrical safety	98
		Cleaning and decontamination	98
		Safety and electromagnetic compatibility (EMC) standards	98
		Safety compliance	99
		EMC	99
		Environmental design	100
		Chemical safety	100
		Biological hazard safety	101
		Documentation and support	102
		Related documentation	102
		Obtain information from the Help system	102
		Customer and technical support	102
		Limited product warranty	103
		Index	104



Product information

■ Instrument hardware description	9
■ Software description	14
■ Supported options for instrument and computer connections	16
■ Experiment types	18

Instrument hardware description

Instrument overview

The QuantStudio™ 1 Real-Time PCR System uses fluorescence-based polymerase chain reaction (PCR) reagents to perform the following types of experiments.

- Quantitative detection of target nucleic acid sequences (targets).
- Qualitative detection of targets.
- Qualitative analysis of the PCR product.

For more information, see “Experiment types” on page 18.



The instrument is configured with a 96-well 0.2-mL fixed block and a 3-color coupled filter set.

The instrument can be run directly from the touchscreen to create and start experiments. To design experiments or to analyze data, the instrument can be integrated with the QuantStudio™ Design and Analysis Software.

An optional barcode scanner and optional wireless adapter can be ordered separately.

Instrument filters and supported dyes

System dyes

The instrument use a coupled three-color filter set that supports the dyes shown in the following table and figure. For more information about available spectral dye calibration kits, contact Support.

Peak filter	Color	Filter wavelength (nm) ^[1]		Factory-calibrated dyes	Example custom dyes
		Excitation	Emission		
x1-m1	Blue	470 ± 15	520 ± 15	FAM™, SYBR™ Green	SYT09
x2-m2	Green	520 ± 10	558 ± 12	VIC™	JOE™, HEX™, TET™ [2]
x4-m4	Orange	580 ± 10	623 ± 14	ROX™, JUN™	Texas Red™

^[1] The central wavelengths are the optimized wavelengths.

^[2] The HEX™ and TET™ dyes from Thermo Fisher Scientific fall within the emission wavelength range of the system, therefore they can be added and adapted for use on the instrument.

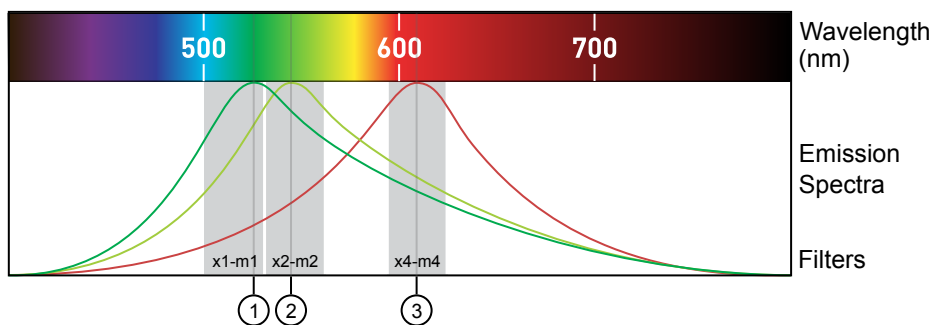

① x1-m1 — FAM™, SYBR™ Green

② x2-m2 — VIC™

③ x4-m4 — JUN™, ROX™, Texas Red™

Custom dyes

The instrument can run assays designed with custom dyes. Custom dyes include the following:

- Dyes that are not supplied by Thermo Fisher Scientific.
- Dyes or formulations of dyes that are not system dyes for the instrument.

To use a custom dye on the instrument, review the following requirements.

- Calibrate the instrument for the custom dye (see “Calibrate custom dyes” on page 62).
- Ensure that the custom dye excites and emits within the wavelength range of the filters (see the filter-wavelength table in “System dyes”).
- Select a custom dye that does not overlap with other dyes used in the run (see the filter-wavelength table in “System dyes”).

Parts of the instrument

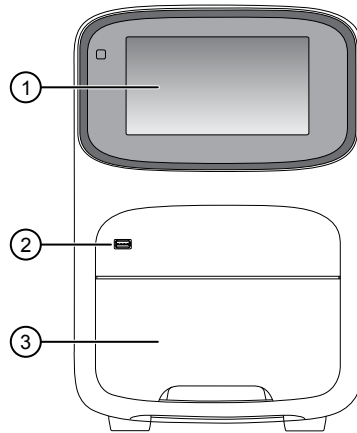

- ① **Touchscreen** – Controls the instrument.
- ② **USB port** – For connection to an external network drive or external data storage device.
- ③ **Instrument drawer** – Contains sample plate.

The instrument includes three additional USB ports on the back of the instrument.









Note: The instrument recognizes only one external storage device at a time for data transfer.

Parts of the home screen



Table 2 Parts of the home screen

Element of the home screen	Function	For more information, see...
Avatar and Instrument name	Set by the administrator to uniquely identify instrument.	"Manage the instrument name (Administrator only)" on page 31.
Help icon	Touch to launch the touchscreen Help system to access step-by-step instructions.	—
Drawer status	<ul style="list-style-type: none"> 🔒 — The drawer is locked. The drawer locks during experiment runs, calibration runs, and self verification test runs. The drawer automatically unlocks when a run is complete. 🔓 — The drawer is unlocked. Drawer is open — The drawer is open. No message displays when the drawer is closed. 	—

Element of the home screen	Function	For more information, see...
Status dial	<ul style="list-style-type: none"> When the instrument is in use — Displays the sample block temperature, the elapsed run time, and the run status. You can swipe the dial to the left or touch  to access real-time views of the run. When the instrument is not in use — Displays Set up run. You can start a run by touching the status dial. 	—
Current user name and block type	<p>Displays the user name of the current signed-in user and the instrument block type.</p> <p>Note: If no user is signed-in, the instrument defaults to the Guest profile.</p>	—
Settings button	Touch  Settings to configure, calibrate, or learn about the instrument.	Chapter 3, “Configure the instrument and manage instrument profiles”.
Buttons for accessing experiment and template files	Load Experiment — Touch to open a user-created EDT file from a Cloud account, USB, instrument folder, or network drive.	“Run an experiment from a saved file” on page 40 .
	Open Template — Touch to open a system EDT template file.	“Create and run an experiment from a template” on page 40 “Run an experiment from a saved file” on page 40 .
	Run Last — Touch to open the last EDT file run on the instrument. <ul style="list-style-type: none"> If you are signed-in, the file opened will be the last file you ran when signed-in. If you are not signed-in, the file opened will be the last file the guest profile ran. 	“Repeat the last instrument run” on page 41.
Connectivity icons	<ul style="list-style-type: none">  — The instrument is connected to a wired network.  — The instrument is wirelessly connected.  — A USB drive is plugged into the instrument.  — The instrument is linked to a Cloud account. 	—
Sign In button (My Profile button when a user is signed in)	<ul style="list-style-type: none"> Touch  Sign In to sign into an instrument profile and link to a Cloud account. Touch  My Profile to change instrument profile settings, link to a Cloud account, or lock the instrument during a run. 	“Sign in” on page 21.





Software description

Instrument, desktop, and cloud software features

The instrument and the software (desktop and cloud) include the features described in the following table.

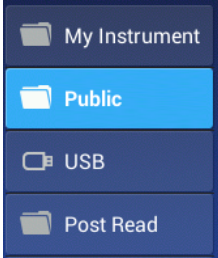
Feature	Instrument	Desktop	Cloud
Use as guest (no sign in)	✓	✓	—
Create templates (unlocked or locked)	—	✓	✓
Edit unlocked templates	✓	✓	✓
Edit locked templates (password assigned by template creator required)	—	✓	✓
Load system or user-created templates (EDT file) to instrument	✓	✓	—
Change experiment settings in template (EDT file) loaded on the instrument Settings that can be changed in a locked template (no password required): <ul style="list-style-type: none"> • Properties: All settings • Method: No changes allowed • Plate: Sample names Settings that can be changed in an unlocked template: <ul style="list-style-type: none"> • Properties: All settings • Method: All settings • Plate: Sample names 	✓	—	—
Load plate in instrument	✓	—	—
Start run	✓	✓	—
View real-time data during a run	✓	✓	✓
View instrument status (running, calibration needed, and so on)	✓	—	✓
Analyze results	—	✓	✓
Set calibration reminders	✓	—	✓
Review exported calibration or RNase P verification results	—	✓	✓ (only RNase P)

Folders, templates, experiments, and projects

Term	Definition	Supported in
Folders in Load Experiment 	Location in which you can store templates (EDT files) on the instrument: <ul style="list-style-type: none"> • My Instrument – Displayed if you are signed in • Public – Location in which all experiments run by guest users are stored • USB – USB for manual transfer to and from a computer • Post Read – If you run an endpoint experiment, the pre-read experiment is automatically saved in this folder for post-read analysis 	Instrument
Experiment Template File (EDT)  	Default settings for an instrument run, can be modified before instrument run. Two types: <ul style="list-style-type: none"> • Factory-provided, accessed from Open Template (instrument) or Create Experiment (desktop or cloud) • User-created, accessed from Load Experiment 	Instrument Desktop Cloud
Experiment Run File (EDS)	Settings and data for a completed instrument run.	Instrument Desktop Cloud
Project 	Function in the Cloud Data Manager that is used for secondary analysis applications. Does not apply to the cloud software, which is a primary analysis application.	Cloud

Template and experiment components	Instrument	Desktop	Cloud
Properties	<ul style="list-style-type: none"> • Experiment file name • Reagent information (Reagent barcode, Lot#) • Plate barcode • Data destination (location for auto-transfer of data) • Comments (Tags are not used at this time) 	<ul style="list-style-type: none"> • Experiment file name • Plate barcode • User name • Instrument type • Block type • Experiment type • Chemistry (reagent information) • Run mode • Comments • <i>{Cloud software only}</i> Notifications 	
Method	Thermal cycling conditions	Thermal cycling conditions	

Template and experiment components	Instrument	Desktop	Cloud
Plate	Sample names You cannot edit targets/SNP assays or tasks on the instrument.	Define and assign samples, targets or SNP assays, and tasks in the Quick Setup and Advanced Setup panes of the Plate tab.	
Run	Start and monitor a run in progress View: Time remaining and Temperature, Method, Plots Pause, Resume, Stop a run	Start and monitor a run in progress View: Time remaining and Temperature, Method, Plots	Monitor a run in progress (link to Thermo Fisher Cloud Instrument Details) View: Time remaining and Temperature, Method, Plots
Results	Not applicable	Review plots	
Export	Not applicable	Export results	

Third-party software

Before installing third-party software on the computer running QuantStudio™ Design and Analysis Desktop Software, confirm that the third-party software will not do the following:

- Restrict Ethernet communication.
- Interfere with instrument or computer operation.

Supported options for instrument and computer connections

We support the following direct, networked (LAN–local area network), or Cloud configurations. Configurations other than those listed are not recommended. Select a configuration that meets the needs of your laboratory's instrument, software, and workflow requirements.

IMPORTANT! Do *not* connect *both* an Ethernet cable and the Wi-Fi module (Cat. No. A26774) to the instrument. Configuring the instrument for both wired and wireless connection can interfere with instrument operation.

Note: For detailed information about networking your instrument, see the *QuantStudio™ 1 Real-Time PCR System IT Checklist* (Pub. No. MAN0018164).

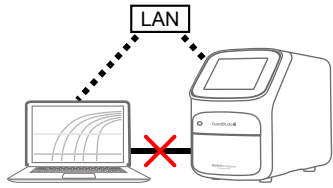
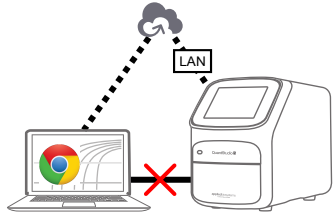
Direct configuration option	
<ul style="list-style-type: none"> A computer provided by Thermo Fisher Scientific with the QuantStudio™ Design and Analysis Desktop Software 	
<ul style="list-style-type: none"> Computer-to-instrument connection: <ul style="list-style-type: none"> Direct, wired connection between the computer and the instrument using an Ethernet cable <p>IMPORTANT! A direct instrument-to-computer connection <i>cannot</i> be combined with the LAN or the Cloud configurations.</p>	
Networked configuration option	
<ul style="list-style-type: none"> A computer provided by Thermo Fisher Scientific with the QuantStudio™ Design and Analysis Desktop Software The computer and instrument must be on the same subnet mask. 	
<ul style="list-style-type: none"> Computer-to-LAN connection <i>(select an option)</i>: <ul style="list-style-type: none"> Wired connection to the network using an Ethernet cable – <i>or</i> – Wireless connection to the network 	
<ul style="list-style-type: none"> Instrument-to-LAN connection <i>(select an option)</i>: <ul style="list-style-type: none"> Wired connection to the network using an Ethernet cable – <i>or</i> – Wireless connection to the network using the instrument Wi-Fi module 	
Thermo Fisher Cloud configuration option	
<ul style="list-style-type: none"> Internet access and a computer with the Chrome™ web browser to access the Cloud 	
<ul style="list-style-type: none"> Computer-to-Cloud connection <i>(select an option)</i>: <ul style="list-style-type: none"> Wired connection to the internet using an Ethernet cable – <i>or</i> – Wireless connection to the internet 	
<ul style="list-style-type: none"> Instrument-to-Cloud connection <i>(select an option)</i>: <ul style="list-style-type: none"> Wired connection to the network using an Ethernet cable – <i>or</i> – Wireless connection to the network using the instrument Wi-Fi module 	

Experiment types

Purpose	Description
Standard curve experiment	
Determines absolute target quantity in samples.	<ol style="list-style-type: none"> 1. The software measures amplification of the target in a standard dilution series and in test samples. 2. The software generates a standard curve using data from the standard dilution series. 3. The software uses the standard curve to interpolate the absolute quantity of target in the test samples.
Relative standard curve experiment	
Determines relative target quantity in samples.	<ol style="list-style-type: none"> 1. The software measures amplification of the target of interest and of an endogenous control target in a standard dilution series, in a reference (calibrator) sample, and in test samples. The endogenous control is a target that is expressed equally in all samples; examples of endogenous controls are β-actin, GAPDH, and 18S ribosomal RNA. The software can algorithmically incorporate multiple endogenous control targets in relative quantification calculations. The reference sample is used as the basis for relative quantification results (or 1\times sample). For example, in a study of drug effects on gene expression, an untreated control is an appropriate reference sample. 2. The software generates standard curves for the target of interest and the endogenous control using data from the corresponding standard dilution series. 3. The software uses the standard curves to interpolate the quantities of the target of interest and the endogenous control in each sample. The target quantity in each sample is then normalized to the sample's endogenous control quantity. 4. To determine the relative quantity of the target in test samples, the software divides the normalized target quantity in the sample by the normalized target quantity in the reference sample.
Comparative C_t ($\Delta\Delta C_t$) experiment	
Determines relative target quantity in samples.	<ol style="list-style-type: none"> 1. The software measures amplification of the target of interest and of an endogenous control target in a reference (calibrator) sample and in test samples. The endogenous control is a target that is expressed equally in all samples; examples of endogenous controls are β-actin, GAPDH, and 18S ribosomal RNA. The software can algorithmically incorporate multiple endogenous control targets in relative quantification calculations. The reference sample is used as the basis for relative quantification results (or 1\times sample). For example, in a study of drug effects on gene expression, an untreated control is an appropriate reference sample. 2. The measurements for the target of interest are normalized to the endogenous control. 3. To determine the relative quantity of the target in test samples, the software compares the normalized ΔC_q (ΔC_t or ΔC_{rt}) for the sample to the normalized ΔC_q (ΔC_t or ΔC_{rt}) for the reference sample.

Purpose	Description
Genotyping experiment	
<p>Detects single nucleotide polymorphism (SNP) variants of a target nucleic acid sequence.</p>	<p>Genotyping experiments use preformulated TaqMan[®] SNP Genotyping Assays that include the following components:</p> <ul style="list-style-type: none"> • Two sequence-specific primers for amplification of sequences containing the SNP of interest • Two allele-specific TaqMan[®] probes for Allele 1 and Allele 2 <ol style="list-style-type: none"> 1. The software normalizes the fluorescence of the reporter dyes to the fluorescence of the passive reference dye in each well. 2. The software plots the normalized reporter dye signal of each sample well on an Allelic Discrimination Plot, which contrasts the reporter dye intensities of the allele-specific probes. 3. The software algorithmically clusters the sample data, and assigns a genotype call to the samples of each cluster according to its position on the plot.
Presence/absence experiment	
<p>Determines the presence or absence of a target nucleic acid sequence in a sample.</p>	<p>The software calls the target present or absent based on an algorithmically determined call threshold. (The call threshold is different from the C_t threshold; the C_t threshold is not used to make calls.)</p>
Melt curve experiment	
<p>Determines the melting temperature (T_m) of the amplification products of a PCR that used intercalating dyes.</p>	<p>In the software, melt curve analysis is included in the default run method for any experiment type that uses intercalating dyes.</p> <ol style="list-style-type: none"> 1. The software plots a melt curve based on the fluorescence of the dye with respect to change in temperature. 2. Using the melt curve, the software calculates the melting temperature (T_m).

2

General procedures to operate the instrument

- Precautions for use 20
- Power on the instrument 21
- Power off the instrument 21
- Sign in 21
- Sign out 21
- Load and unload a plate in the QuantStudio™ 1 Real-Time PCR Instrument .. 22
- Transfer, view, or manage files and results 23

Precautions for use

 **CAUTION! PHYSICAL INJURY HAZARD.** Do not remove the instrument cover. There are no components inside the instrument that you can safely service yourself. If you suspect a problem, contact technical support.

 **CAUTION! FIRE HAZARD.** For continued protection against the risk of fire, replace fuses only with listed and certified fuses of the same type and rating as those currently in the instrument.

 **CAUTION! PHYSICAL INJURY HAZARD.** During instrument operation, the sample block temperature can reach 100°C. Allow it to cool to room temperature before handling.

 **CAUTION!** Before using a cleaning or decontamination method other than those recommended by Thermo Fisher Scientific, confirm with Thermo Fisher Scientific that the proposed method will not damage the instrument.

 **CAUTION!** Use flat caps for tubes. Rounded caps can damage the heated cover.

Power on the instrument

1. Touch anywhere on the touchscreen to determine if the instrument is in sleep mode. If the home screen is displayed, the instrument is already powered on.
2. If the home screen does not display, power on the instrument by pressing the switch on the rear panel.

If left unattended (for about two hours), the instrument automatically enters sleep mode (enabled by default) to conserve power.

Note: To customize the sleep mode setting, touch  **Settings** ▶ **Instrument Settings** ▶ **Sleep Mode**.

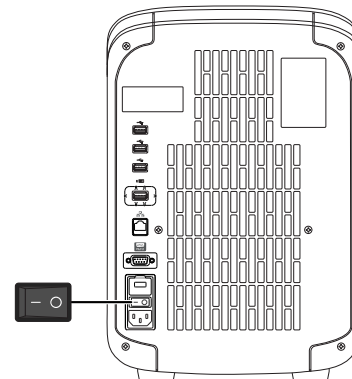

Power off the instrument

The instrument operates in low-power mode when not in use. However, the instrument can be powered off completely so that the components use no power.

Note: To power off the instrument for >1 week, see “Prepare the instrument to store, move, or ship” on page 74.

1. Power off the instrument using the power switch on the back of the instrument.
2. Power off the computer.

Sign in

Create an instrument profile before signing into the instrument. See “Create a new instrument profile” on page 27.

Note: An instrument profile is a user account specifically for the instrument. It is not related to any other user account for the system or software.

1. In the home screen, touch  **Sign In**.
2. Touch **Sign In**, then select your username.
3. Enter your PIN, then touch **Enter**.

Sign out

1. In the home screen, touch  **My Profile**.
2. Touch **Sign Out**.

Load and unload a plate in the QuantStudio™ 1 Real-Time PCR Instrument

 **CAUTION!** Use flat caps for 0.2-mL tubes. Rounded caps can damage the heated cover.

1. Load the plate.
 - a. Open the instrument drawer.
 - b. Load the plate onto the plate adapter so that the following criteria are met.
 - Well A1 of the plate is in the top-left corner of the plate adapter.
 - The barcode faces the front of the instrument.

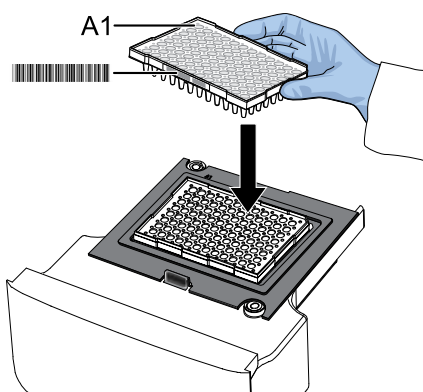

Note: Do not remove the black plate adapter before loading a plate or tube strips. If used, tube strips can fit loosely in the adapter, but the heated cover will apply the appropriate pressure to seat the tube strips securely in the adapter.

- c. Close the instrument drawer.
2. When the run ends, unload the plate.
 - a. Open the instrument drawer.
 - b. Remove the plate.
 - c. Close the instrument drawer.



CAUTION! PHYSICAL INJURY HAZARD. During instrument operation, the plate temperature can reach 100°C. Allow it to cool to room temperature before handling.

Transfer, view, or manage files and results

Transfer EDS files from the instrument home screen

1. In the home screen, when a run ends, touch **Transfer File**.
2. Select the data destination for the EDS file.
3. Navigate to and select a folder.
4. Touch **OK**.
5. Touch **Transfer**.

Note: Touch  **Settings** ▶ **Run History** to transfer EDS files at any time.

View run history and delete or transfer files from the instrument

In the home screen, touch  **Settings** ▶ **Run History**.



- Touch an individual run record to view its details, then complete one of the following actions:
 - Touch **Delete** to delete the run record.
 - Touch **Transfer** to export the run data.
- Touch **Manage** to select multiple run records for simultaneous viewing, deletion, or transfer.



Note:

- Guests (users not signed-in) can only view guest run records.
- Users signed into their instrument profiles can also view their own run records.
- Administrators can view all run records.

Note: If the connection between the instrument and the desktop software is interrupted during the run, the instrument still completes the run. However, the run data (EDS file) must be transferred from the instrument to the desktop software using a USB drive or a network drive.

Manage templates (EDT files)

This feature applies to templates (EDT files) on a  **USB** or in  **My Instrument**. To manage run results files (EDS files), see “Transfer EDS files from the instrument home screen” on page 23.

1. In the home screen, touch  **Load Experiment**.
2. Touch  **USB** or  **My Instrument**.
3. Touch **Manage Files**.
4. (Optional) Navigate through the **My Instrument**, **Public**, **USB**, and **Post Read** folders to access an EDT file. Folder availability depends on your sign-in status.
5. Touch one or more files to select for managing.

6. Delete or copy the files.
 - Touch **Delete Files**, then confirm deletion.
 - Touch **Copy Files**, select a file destination, then touch **Paste Files**.
7. Touch **Done**.

3

Configure the instrument and manage instrument profiles

■ Initial start-up	25
■ Installation and instrument verification	26
■ Use the instrument without signing in	26
■ Create an administrator instrument profile during initial start-up	27
■ Create a new instrument profile	27
■ Overview of Settings	28
■ Manage instrument settings	30
■ Learn about the instrument	34
■ Manage home screen notifications	35
■ Manage maintenance, service, and calibrations	35
■ Manage Users	36
■ Link an instrument profile with the Thermo Fisher Cloud	38

Initial start-up

Perform these tasks during initial instrument start-up or after you restore factory defaults (see “Restore factory defaults” on page 34).

1. *(Optional)* Select one of the following options.
 - Configure the instrument for either wired connection or wireless network connection (see “Configure the network” on page 32).
 - Touch **Neither/Decide Later**.
2. *(Optional)* Enter an instrument name (see “Manage the instrument name (Administrator only)” on page 31).
3. Set the date and time (see “Set the date and time (Administrator only)” on page 32).
4. Select one of the following options.
 - Select a Cloud region (see “Select a Cloud region (Administrator only)” on page 32).
 - Touch **Next** to continue.

5. Create an administrator profile (see “Create an administrator instrument profile during initial start-up” on page 27).
6. Select one of the following options.
 - Link the instrument profile to the Thermo Fisher Cloud (see “Link an existing instrument profile with the Thermo Fisher Cloud” on page 38).
 - Touch **Skip**.

Installation and instrument verification

Before the first use of the instrument, complete the following tasks:

- Install the instrument (see “Unpack and install the instrument” on page 79).
- Verify instrument performance (see “Perform instrument verification using RNase P plates” on page 57).

Note:

- Instruments are factory calibrated, so no calibration is necessary at installation. However, we recommend that you verify instrument performance before using the instrument.
- Regular calibration and verification should be performed according to the calibration and verification schedule (see “Calibration and verification schedule” on page 49).

Use the instrument without signing in

If the instrument is configured by an Administrator to allow guest access (**⊛ Settings ▶ Manage Users ▶ Sign In Required** set to off), you can use the instrument without signing in.

The following limits are in place if you do not sign in to the instrument:

- All actions are recorded to **Guest** user profile.
- You have access only to the **Public** folder for selecting and storing experiments.
- You cannot transfer data to the Cloud (only to USB or network drive).

Create an administrator instrument profile during initial start-up

During initial start-up, the user is automatically prompted to create an administrator instrument profile. See “Initial start-up” on page 25.

- The first instrument profile that is created during installation is given administrator privileges.
 - Administrators can grant administrative privileges to other users. See “Manage all instrument profiles (Administrator only)” on page 37.
1. Touch **Name**, enter a username, then touch **Done**.
 2. Touch **PIN**, enter a four-digit numerical password, then touch **Enter**.
Note: Touch the **Show PIN** checkbox to switch PIN display on or off.
 3. Touch **Confirm PIN**, then repeat step 2.
 4. Touch **Create profile**.

Create a new instrument profile

1. In the home screen, touch  **Sign In**, then touch **Get Started**.
2. Touch **Name**, enter a username, then touch **Done**.
3. Touch **PIN Code**, enter a four-digit numerical password, then touch **Enter**.
Note: Touch the **Show PIN** checkbox to switch PIN display on or off.
4. Touch **Confirm PIN**, then repeat step 2.
5. Touch **Create profile**.
6. Sign in to the profile you just created. See Sign in.

Note: To enable access to the Thermo Fisher Cloud, see “Link an instrument profile with the Thermo Fisher Cloud” on page 38.

Overview of Settings

Touch  **Settings** in the home screen to configure settings as needed.

Access to many settings are restricted to administrator instrument profiles.



Touch  for step-by-step instructions on configuring settings.

Options	Description
Instrument Settings	
Instrument Name (Administrator only)	Enter a unique instrument name, and <i>(optional)</i> set an instrument avatar.
Sleep Mode	Enable the instrument to enter a standby mode after a set length of inactivity.
Heated Cover Temperature	Set the idling temperature for the heated cover (before it enters sleep mode).
Network Drive^[1]	Specify a default network drive for transferring files from the instrument.
Insert Plate Reminder	Enable a reminder to insert a plate before starting a run from the instrument.
OEM Connection Only (Administrator only)	Required for API access to the instrument. When enabled, the software (desktop and cloud) cannot connect to the instrument. API access to the instrument is exclusive to authorized OEM partners.
Cloud Region (Administrator only)	Specify the regional server location to access the Thermo Fisher Connect Dashboard. Note: Once you set a Cloud region, restore factory defaults to change the region.

Options	Description
Date/Time	Set time zone and date and time formats.
Network Connection	Set wired or wireless network connection for the instrument.
Restore Factory Defaults	<p>Restore the instrument to the factory settings.</p> <p>IMPORTANT! Back up the instrument before restoring factory defaults (see “Backup or restore the instrument” on page 70).</p> <p>Note: Restoring an instrument to the factory defaults results in the following setting changes:</p> <ul style="list-style-type: none"> • Instrument profiles and files stored on the instrument are deleted, including all EDS files and any custom dye calibrations. • The most recent valid ROI/Uniformity, Background, and system dye calibrations are not deleted.
Language	Specify the language to display on the touchscreen.
About Instrument	
About Instrument	Displays the instrument Model Name , Block Serial Number , and Firmware Version .
License Agreement	Displays the End User Software License Agreement and the Limited Product Warranty. You can export the License Agreement to a USB drive.
Notifications	
—	<p>Enable home screen notifications of instrument errors and software updates. This function is not related to the Notifications function in the cloud software.</p> <p>The number of new, unviewed notifications displays over Settings in the home screen.</p>
Maintenance and Service	
Software Update (Administrator only)	Update the instrument software.
Monitoring (Administrator only)	<p>Enable the Remote Monitoring Service to automatically notify Thermo Fisher Scientific support teams in real-time of potential instrument problems.</p> <p>The service monitors and sends general <i>instrument</i> data, but the service does not monitor or send <i>customer</i> data.</p>
Instrument Statistics	Displays instrument usage information including Block Cycle Count and LED Life .
Calibrations	<ul style="list-style-type: none"> • Perform calibrations <ul style="list-style-type: none"> – ROI and Uniformity – Dye – Custom (including Background calibration) • View calibration history and set calibration reminders in History and Reminders
RNase P Verification	Perform instrument performance verification using an RNase P plate.
Self Verification Test	Check the instrument hardware functions.
Log	View and export Instrument Run Log .

Options	Description
Backup / Restore	<ul style="list-style-type: none"> • Backup the instrument^[1] • Restore an instrument backup
Ship Prep Mode	Place the instrument in a safe state for moving or long term storage.
Run History	
—	Displays the instrument runs and whether the EDS file for the run was transferred. Touch a run to view the details or to transfer or delete (Administrator only) the EDS file.
Manage Users	
Sign In Required (Administrator only)	Enable only signed-in users to access the instrument for any task, including accessing Settings . Enabling this feature disables the guest profile access to the instrument. Note: Instrument runs must be started from the desktop software, and actions during an instrument run are automatically logged to the guest instrument profile (even if a user was signed into the instrument).
Sign Out Timer (Administrator only)	Set the time length of inactivity before a user is automatically signed out.
Manage Profiles (Administrator only)	Access the profile information for the instrument.

^[1] Also available to standard and guest instrument profiles.

Manage instrument settings

In the home screen, touch  **Settings** ▶ **Instrument Settings** to access the following functions.

“Manage the instrument name (Administrator only)” on page 31

“Enable Sleep Mode” on page 31

“Set the idling temperature for the heated cover” on page 31

“Configure the network drive” on page 31

“OEM connection only (Administrator only)” on page 31

“Select a Cloud region (Administrator only)” on page 32

“Set the date and time (Administrator only)” on page 32

“Configure the network” on page 32

“Restore factory defaults” on page 34

“Select a language” on page 34

Manage the instrument name (Administrator only)

1. In the home screen, touch **Settings** ▶ **Instrument Settings** ▶ **Instrument Name**.
2. Touch the **Instrument Name** field, enter an instrument name, then touch **Done**.
3. *(Optional)* Touch **Add Avatar** to associate an avatar with the instrument. Insert a USB drive with image files to use this option.
4. Touch **OK**.

Enable Sleep Mode

1. In the home screen, touch **Settings** ▶ **Instrument Settings** ▶ **Sleep Mode**.
2. Slide the control **On** to enable sleep mode.
3. Touch **Edit Time**, then enter the time length of inactivity before the instrument enters sleep mode.
4. Touch **Enter**, then touch **OK**.

Set the idling temperature for the heated cover

1. In the home screen, touch **Settings** ▶ **Instrument Settings** ▶ **Heated Cover Idle Temperature**.
2. Slide the control **On** to set the idling temperature for the heated cover.
3. Touch the **Edit Temperature** field, then enter the desired idling temperature.
4. Touch **Enter**, then touch **OK**.

Configure the network drive

1. In the home screen, touch **Settings** ▶ **Instrument Settings** ▶ **Network Drive**.
Note: Contact a representative from your information technologies department for the IP address.
2. Enter a **Drive Location**.
3. Enter a **Domain Name**, **User Name**, and **Password**, if required.
4. Touch **Connect**.

OEM connection only (Administrator only)

This setting is required for API access to the instrument. When enabled, the desktop software cannot connect to the instrument. Do not access unless instructed to do so by a service representative.

Select a Cloud region (Administrator only)

During the initial startup, you will be automatically prompted to select a Cloud region. Return to the selection through  **Settings**, if necessary.

1. In the home screen, touch  **Settings** ▶ **Instrument Settings** ▶ **Cloud Region**.
2. Touch a region.
The server used to store your data is located in this region.
3. Touch **OK**.

Set the date and time (Administrator only)

1. In the home screen, touch  **Settings** ▶ **Instrument Settings** ▶ **Date/Time**.
2. Select a time zone from the dropdown list.
3. Select a date format.
 - a. Touch **Date Format**, then select the preferred date format.
 - b. Touch **Next**, touch the date field, then enter the date.
 - c. Touch **Enter**, then touch **Done**.
4. Select a time format.
 - a. Touch **Time Format**.
 - b. Slide the control to select a 12-hour or 24-hour clock.
 - c. Touch **Next**, touch the time field, then enter the time.
 - d. Touch **Enter**, then touch **Done**.
5. Touch **Done**.



Configure the network

IMPORTANT! Configure the instrument for either wired connection or wireless connection but not both.

 "Set up a wired connection" on page 33

 "Set up a wireless connection" on page 33

Set up a wired connection



1. In the home screen, touch  **Settings** ▶ **Instrument Settings** ▶ **Network Connection** ▶  **Wired**.
2. In the **Network Configuration** screen, touch a radio button to connect to a network either by **DHCP** or by a **Static IP** address.

Option	Action
Automatic	Touch DHCP .
Manual	<ol style="list-style-type: none"> 1. Touch Static IP. 2. Enter the IP address for the instrument, the Subnet Mask, the Default Gateway, and <i>optional</i> the Primary DNS Server and the Secondary DNS Server. Addresses are in the form of X.X.X.X, where each X is a number from 0 to 255.

Note: Ask your system administrator if the IP address is assigned statically or dynamically. For static addresses, you need to know the **IP address** for the instrument, the **Subnet Mask**, and the **Default Gateway**.

3. Touch **OK**.

Set up a wireless connection

1. In the home screen, touch  **Settings** ▶ **Instrument Settings** ▶ **Network Connection** ▶  **Wireless** to display a list of the available networks.
2. Select a network or touch **Join other network**, enter the network password, then touch **Enter**.
If you select **Join other network**, enter the network name and security type.
3. Touch **Join** to continue.
4. In the **Network Connection Complete** screen, touch **Next**.
5. Touch **OK**.
6. In the **Network Configuration** screen, edit the Network details or touch **Done**.

Restore factory defaults

IMPORTANT! Back up the instrument before restoring factory defaults (see “Backup or restore the instrument” on page 70).

1. In the home screen, touch **⊗ Settings ▶ Instrument Settings ▶ Restore Factory Defaults**.
2. Touch **Restore Factory Defaults**.
3. Power **Off**, then power **On** the instrument to apply the change.
 - Instrument profiles and files stored on the instrument are deleted, including all EDS files and any custom dye calibrations.
 - The most recent valid ROI/Uniformity, Background, and system dye calibrations are not deleted.

After restoring factory defaults, perform initial start-up tasks. See “Initial start-up” on page 25.

Select a language

1. In the home screen, touch **⊗ Settings ▶ Instrument Settings ▶ Language**.
2. Touch the desired language selection.
3. Touch **OK**.

Learn about the instrument

In the home screen, touch **⊗ Settings ▶ About Instrument** to access the following information.

“View instrument specifications” on page 34

“View and export the License Agreement” on page 35

View instrument specifications

In the home screen, touch **⊗ Settings ▶ About Instrument ▶ About Instrument** to access the following information.

- Model Name
- Wired IP Address
- Wireless IP Address
- Instrument Serial Number
- Block Serial Number
- UUID
- Firmware Version
- Thermal Block Controller
- Instrument Server
- User Interface

View and export the License Agreement

1. In the home screen, touch  **Settings** ▶ **About Instrument** ▶ **License Agreement** to view the license agreement.
2. Touch **Export** to export the license agreement.
3. Touch **Done**.

Manage home screen notifications

1. In the home screen, touch  **Settings** ▶ **Notifications** to view and manage **Home Screen Notifications**.
2. Slide the control **On** or **Off** to enable or disable individual notifications, or touch **Clear All** to remove all notifications.
3. Touch **Close**.

Manage maintenance, service, and calibrations

In the home screen, touch  **Settings** ▶ **Maintenance and Service** to access the following functions.

“Update instrument software (Administrator only)” on page 35

“Enable remote instrument monitoring (Administrator only)” on page 36

“View instrument statistics” on page 36



Chapter 5, “Calibrate and verify instrument performance”

“View instrument logs” on page 36

“Backup or restore the instrument” on page 70

“Prepare the instrument to store, move, or ship” on page 74

Update instrument software (Administrator only)

1. In the home screen, touch  **Settings** ▶ **Maintenance and Service** ▶ **Software Update**.
2. Touch  **USB** or  **Cloud** to select the location of the update files.
3. When prompted, confirm your request to update the software.

Enable remote instrument monitoring (Administrator only)

1. In the home screen, touch  **Settings** ▶ **Maintenance and Service** ▶ **Monitoring**.
2. Configure the instrument monitoring settings.

Option	Description
Remote Monitoring Service	Slide the control On to enable the Remote Monitoring Service . Enabling the Remote Monitoring Service allows the instrument to automatically notify Thermo Fisher Scientific support teams in real time of potential instrument issues. The service monitors and sends general <i>instrument</i> data, but the service does not monitor or send <i>customer</i> data.
Thermo Fisher Cloud Monitor	Slide the control On to enable users to access real-time monitoring of amplification plots from the Thermo Fisher Cloud dashboard.





3. Touch **OK**.

View instrument statistics

In the home screen, touch  **Settings** ▶ **Maintenance and Service** ▶ **Instrument Statistics** to view the following statistics.

- Disk Space Remaining (MB)
- Block Cycle Count
- Block Degrees Climbed
- LED Life
- RNase P Status

View instrument logs

1. In the home screen, touch  **Settings** ▶ **Maintenance and Service** ▶ **Log**.
2. Touch **Instrument Run Log** to view the log records.
3. (Optional) Touch a category on the left to filter the log table by event type.
4. (Optional) Touch an individual log record to view details.
5. (Optional) Export log records:
 - Touch **Export** ▶  **USB**.
 - Touch **Export** ▶  **Cloud**, then touch **Export**.
 - Touch **Export** ▶  **Network**.

Manage Users

In the home screen, touch  **Settings** ▶ **Manage Users** to access the following functions.

- “Require instrument profile sign-in (Administrator only)” on page 37.
- “Manage the Sign Out Timer (Administrator only)” on page 37.
- “Manage all instrument profiles (Administrator only)” on page 37.

Require instrument profile sign-in (Administrator only)

1. In the home screen, touch  **Settings** ▶ **Manage Users** ▶ **Sign In Required**.
2. Slide the control **On**.
Only signed-in users are allowed to access the instrument for any task, including access to **Settings**.
3. Touch **Done**.

Manage the Sign Out Timer (Administrator only)



1. In the home screen, touch  **Settings** ▶ **Manage Users** ▶ **Sign Out Timer**.
2. Touch the **Edit Time** field, then enter the desired duration of inactivity before automatic user sign out.
3. Touch **Enter**, then touch **Done**.

Manage instrument profiles



Note: An instrument profile is a user account specifically for the instrument. It is not related to any other user account for the system or software.

To	See
Create a profile	<ul style="list-style-type: none"> • “Create an administrator instrument profile during initial start-up” on page 27 • “Create a new instrument profile” on page 27
Configure a profile	<ul style="list-style-type: none"> • “Link an instrument profile with the Thermo Fisher Cloud” on page 38 • “Edit an instrument profile” on page 37
View or manage all profiles	<ul style="list-style-type: none"> • “Manage all instrument profiles (Administrator only)” on page 37

Edit an instrument profile

1. In the home screen, touch  **My Profile**.
Note: Administrators can also navigate to this screen by touching  **Settings** ▶ **Manage Users** ▶ **Manage Profiles**.
2. Touch **Edit**.
3. Select the fields to edit, then make changes.
4. Touch **Done**.

Manage all instrument profiles (Administrator only)

1. In the home screen, access the **All Profiles** tab.
 - Touch  **My Profile** ▶ **All Profiles**.
 - Touch  **Settings** ▶ **Manage Users** ▶ **Manage Profiles** ▶ **All Profiles**.

A list of users, the date the profile was created, and the user type displays.
2. Select the instrument profile to edit.

3. Edit the profile.
 - To delete the profile, touch **Delete profile** ▶ **Delete**.
 - To reset the PIN, touch **Reset PIN** ▶ **Reset**.
 - The user will be directed to enter a new PIN at the next sign in.
 - To enable or disable administrative privileges, slide the control to **Administrator** or **Standard**, respectively.
4. Touch **Done**.

Link an instrument profile with the Thermo Fisher Cloud

Linking your instrument profile with the Thermo Fisher Cloud allows you to access the following functions:

- View an instrument status from the Cloud.
- Download templates from your Cloud storage to the instrument.
- Transfer run data from the instrument to your Cloud storage.

To link an instrument profile with the Thermo Fisher Cloud, see the following sections:

- “Link an existing instrument profile with the Thermo Fisher Cloud”
- “Create a new instrument profile and link with the Thermo Fisher Cloud”

Link an existing instrument profile with the Thermo Fisher Cloud

1. Sign in to your instrument profile. See “Sign in” on page 21.
2. Touch  **My Profile**.
3. Touch **Cloud**.
4. Enter your username and password, then touch **Link Account**.
5. Touch **Done**.

Your instrument profile is linked with the Thermo Fisher Cloud.

Create a new instrument profile and link with the Thermo Fisher Cloud

1. Select an option to create a new instrument profile.
 - Create an administrator profile (see “Create an administrator instrument profile during initial start-up” on page 27).
 - Create an instrument profile (see “Create a new instrument profile” on page 27).
2. In the **Get Started – Cloud** screen, enter your username and password.
3. Touch **Link Account**.

Your instrument profile is linked with the Thermo Fisher Cloud.



Create and run experiments on the instrument

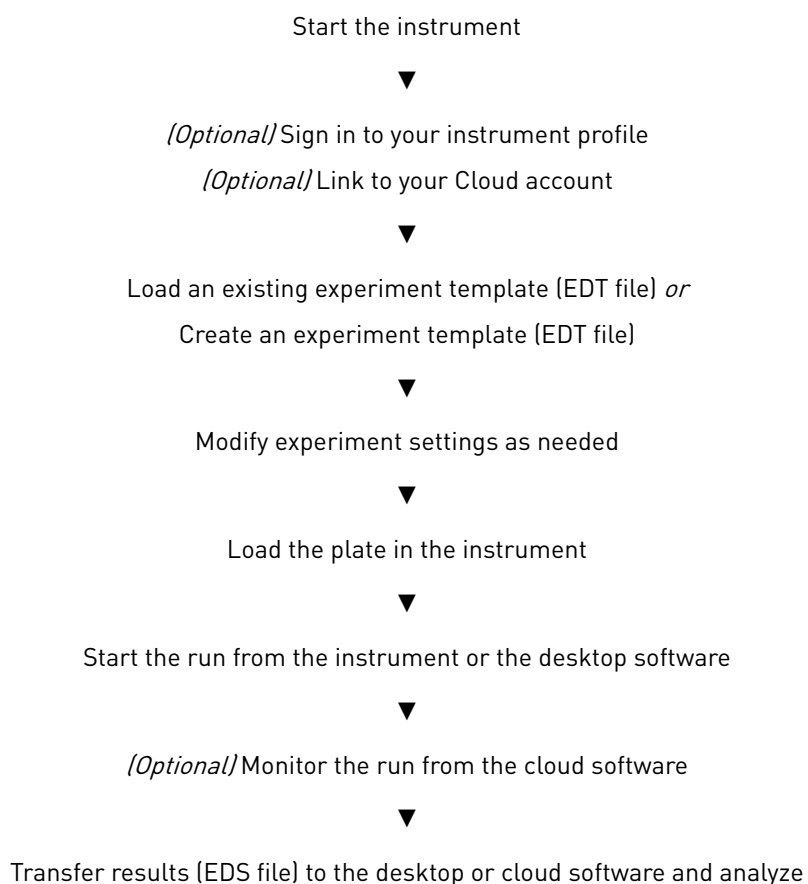

- Workflow 39
- Run an experiment 40
- Edit an experiment before starting a run 41
- View, pause, or stop a run 46
- Transfer EDS files from the instrument home screen 48

Workflow









Run an experiment

Create and run an experiment from a template

1. In the home screen, touch  **Open Template**.
2. *(Optional)* Touch a category in the left column.
3. Touch the file name.
4. *(Optional)* Enter or edit template properties, including **Run File Name** (EDS file name), **Plate Barcode**, **Reagent Information**, and **Data Destination** (see “Enter or edit template properties”).
5. *(Optional)* Edit the run method (see “Edit the run method” on page 43).
 - Add, remove, or edit a step, stage, melt curve, or data collection point.
 - Adjust the heated cover temperature, sample volume, or number of cycles.
 - Configure ramp rate and pause settings.
6. *(Optional)* Define plate wells with sample names and view **Well ID**, **Targets**, or **Dyes** (see “Define, assign, and view well details”).
7. Load a plate into the instrument (see “Load and unload a plate in the QuantStudio™ 1 Real-Time PCR Instrument” on page 22).
8. Touch **Start Run**.
When prompted, confirm that you inserted a plate.
Note: To disable this reminder, select **Do not show again** or select  **Settings** ▶ **Insert Plate Reminder** in the home screen.



Run an experiment from a saved file

1. In the home screen, touch  **Load Experiment**.
2. Touch the appropriate icon to navigate to your file location.
 - For files saved to the guest profile, touch  **My Instrument** ▶ **Public**.
 - For pre and post read files, touch  **My Instrument** ▶ **Post Read**.
3. Touch the file name.
4. *(Optional)* Manage templates in either  **USB** or  **My Instrument** (see “Manage templates (EDT files)”).
5. *(Optional)* Enter or edit template properties, including **Run File Name** (EDS file name), **Plate Barcode**, **Reagent Information**, and **Data Destination** (see “Enter or edit template properties”).
6. *(Optional)* Edit the run method (see “Edit the run method” on page 43).
 - Add, remove, or edit a step, stage, melt curve, or data collection point.
 - Adjust the heated cover temperature, sample volume, or number of cycles.
 - Configure ramp rate and pause settings.

7. (Optional) Define plate wells with sample names and view **Well ID, Targets, or Dyes** (see “Define, assign, and view well details”).
8. Load a plate into the instrument (see “Load and unload a plate in the QuantStudio™ 1 Real-Time PCR Instrument” on page 22).
9. Touch **Start Run**.
When prompted, confirm that you inserted a plate.
Note: To disable this reminder, select **Do not show again** or select  **Settings** ▶ **Insert Plate Reminder** in the home screen.

Repeat the last instrument run

This feature applies only to runs started from the instrument and is not available for runs started from the desktop software. If you are signed-in, this feature applies to the last run from your instrument profile.

1. In the home screen, touch  **Run Last**.
2. (Optional) Enter or edit template properties, including **Run File Name** (EDS file name), **Plate Barcode, Reagent Information, and Data Destination** (see “Enter or edit template properties”).
3. (Optional) Edit the run method (see “Edit the run method” on page 43).
 - Add, remove, or edit a step, stage, melt curve, or data collection point.
 - Adjust the heated cover temperature, sample volume, or number of cycles.
 - Configure ramp rate and pause settings.
4. (Optional) Define plate wells with sample names and view **Well ID, Targets, or Dyes** (see “Define, assign, and view well details”).
5. Load a plate into the instrument (see “Load and unload a plate in the QuantStudio™ 1 Real-Time PCR Instrument” on page 22).
6. Touch **Start Run**.
When prompted, confirm that you inserted a plate.
Note: To disable this reminder, select **Do not show again** or select  **Settings** ▶ **Insert Plate Reminder** in the home screen.

Edit an experiment before starting a run



Enter or edit template properties

Access a template (EDT file). For more information, see the following sections.

- “Create and run an experiment from a template” on page 40.
- “Run an experiment from a saved file” on page 40.
- “Repeat the last instrument run” on page 41.

In the **Properties** screen, touch **Edit** to enter or edit template properties.

- Edit the file name for the EDS file for the run.
 - a. Touch the **Run File Name** field.

- b. Enter the name for the EDS file, then touch **Done**.
 - Enter a plate barcode.
 - a. Touch the **Plate Barcode** field.
 - b. Enter or scan the plate barcode, then touch **Done**.
 - Record reagents and their expiration dates.
 - a. Touch  **Reagent Information**.
 - b. Touch **Add**, or touch an existing reagent, then touch **Edit** or **Delete**.
 - c. Touch the **Name**, **Type**, **Lot #**, **Reagent Barcode**, **Part #**, or **Expiration Date** field to enter individual reagent information.
 - d. Touch **Done**.
 - Automatically transfer run data (EDS file) when an instrument run ends.
 - a. Touch  **Data Destination**.
 - b. Touch the appropriate icon to select a data destination.
 - c. Under the desired data destination, select **Automatically transfer experiment**.
 - d. Touch **Done**.
 - Enter a comment.
 - a. Touch **Comments**.
 - b. Enter text, then touch **Done**.

Scan a barcode using the optional barcode scanner

The instrument is compatible with an optional Handheld Barcode Scanner (Cat. No. 4488442, purchased separately). The barcode scanner reads Code 128 (alphanumeric), which supports 128 ASCII character barcodes.

1. Click the **Barcode** field.
2. Hold the scanner 20–30 cm away from a plate or container label and aim at the center of the barcode, then press the trigger.
3. Slowly move the scanning beam across the barcode until the scanner emits a high-pitched tone.

When the scanner scans a barcode, it automatically transmits the following information:

- Transmits the alphanumeric equivalent of the barcode to the barcode field.
- Transmits other reagent information (Lot #, Part #, Expiration Date, etc.)

For more information about the hand-held barcode scanner, see the user documentation provided with the barcode scanner.

Edit the run method

Access a template (EDT file). For more information, see the following sections.

- “Create and run an experiment from a template” on page 40.
- “Run an experiment from a saved file” on page 40.
- “Repeat the last instrument run” on page 41.

For an overview of the method as it is graphically represented on the touchscreen, see “Method elements” on page 43.

1. In the **Method** screen, touch **Edit**.
2. Touch a field, enter changes, then touch **Enter**.
Note: Touch-drag ≡ to quickly increase or decrease a step temperature.
3. Touch “**Manage steps, stages, melt curves, and data collection points**” to add or remove a step, stage, melt curve, or data collection point.

Note: The **Manage Steps** screen also provides access to configuring **Ramp Rates** and **Add Pause** settings. See “Configure ramp rates and pause settings” on page 45.

Method elements

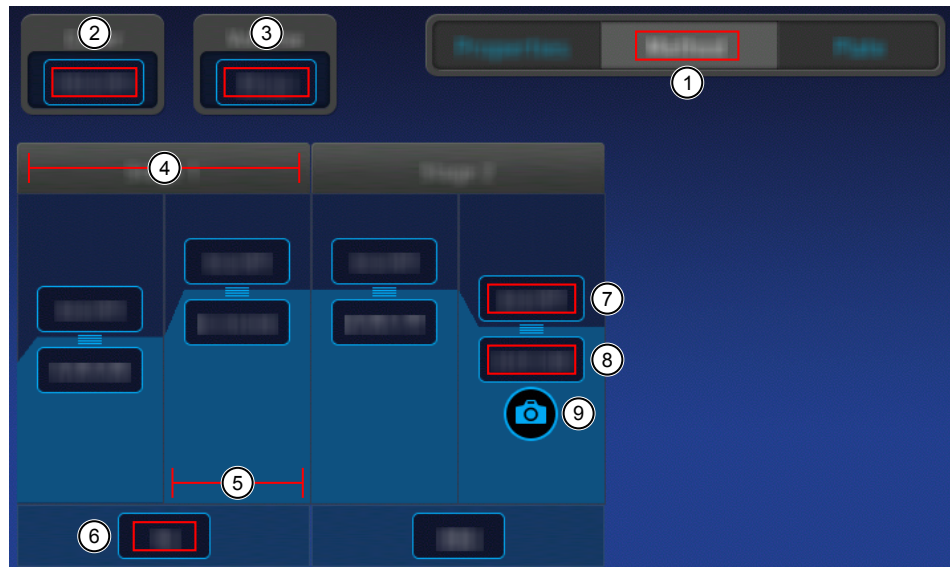

- | | |
|-----------------------------|----------------------------------|
| ① Method tab | ⑥ Number of cycles for the stage |
| ② Heated cover temperature | ⑦ Temperature for the step |
| ③ Reaction volume | ⑧ Hold time for the step |
| ④ Stage of thermal protocol | ⑨ Data collection point |
| ⑤ Step within a stage | |

Manage steps, stages, melt curves, and data collection points

Add or remove a step, stage, melt curve, or data collection point using the **Manage Steps** option. You can also configure ramp rates and pause settings from the **Manage Steps** screen (see “Configure ramp rates and pause settings” on page 45).

- In the **Method** screen, touch **Edit** ▶ **Manage Steps**.

Option	Procedure
Add a step	<ol style="list-style-type: none"> 1. Touch Add/Remove steps ▶ Add steps. 2. Touch + on the left or right border of a step to add a step before or after the step, respectively. 3. Enter parameters for the new step, then touch Enter. 4. Touch Done.
Remove a step	<ol style="list-style-type: none"> 1. Touch Add/Remove steps ▶ Remove steps. 2. Touch — on the step to be removed, then touch Done.
Add a stage	<ol style="list-style-type: none"> 1. Touch Add/Remove stages ▶ Add stages. 2. Touch + on the left or right border of a stage to add a stage before or after the stage, respectively. 3. Edit parameters of the new stage in the Method screen. See “Edit the run method” on page 43. 4. Touch Done.
Remove a stage	<ol style="list-style-type: none"> 1. Touch Add/Remove stages ▶ Remove stages. 2. Touch — on the stage to be removed, then touch Done.
Add a melt curve	<ol style="list-style-type: none"> 1. Touch Melt curves ▶ Add melt curve. 2. Touch + on the left or right border of a step to add a melt curve before or after the step, respectively. 3. Select Continuous or Step and hold. 4. Touch melt curve parameters to edit, then touch Done. 5. Touch Done. <p>Note: Depending on the experiment type, there can be restrictions on the addition or placement of melt curves.</p>
Remove a melt curve	<ol style="list-style-type: none"> 1. Touch Remove melt curve. 2. Touch — on the melt curve to be removed, then touch Done.
Add or remove data collection points	<ol style="list-style-type: none"> 1. Touch Data collection location. 2. Touch  to switch data collection on or off.

Configure ramp rates and pause settings



- In the **Method** screen, touch **Edit** ▶ **Manage Steps** ▶ **Advanced Options**.

Option	Procedure
Edit Ramp Rates	<ol style="list-style-type: none"> 1. Touch Ramp Rates. 2. Touch the ramp rates fields. 3. Touch Enter. 4. <i>(Optional)</i> Edit additional steps, then touch Done.
Add a pause	<ol style="list-style-type: none"> 1. Touch Add Pause. 2. Touch in a stage. 3. Enter the pause temperature, and the cycle after which the pause will occur. 4. Touch Enter. 5. The pause is represented by a P in the corner of the stage. 6. Touch Done.

Define, assign, and view well details

- Access a template (EDT file). For more information, see the following sections.
 - “Create and run an experiment from a template” on page 40.
 - “Run an experiment from a saved file” on page 40.
 - “Repeat the last instrument run” on page 41.
- In the **Plate** screen, define, assign, and view well details.



Option	Procedure
Define and assign samples in the plate layout view	<ol style="list-style-type: none"> 1. Touch . 2. Touch Manage or touch an individual well. 3. Touch the Samples subtab. 4. Select one or more wells, then touch Edit. 5. Enter sample names for the selected wells, then touch Done.

Option	Procedure
Define and assign samples in the well table view	<ol style="list-style-type: none"> 1. Touch . 2. Touch Edit to edit sample names for individual wells. 3. Touch a sample name field, enter a new name, then touch Done.
View target information	<ol style="list-style-type: none"> 1. Touch . 2. Touch Manage or touch an individual well. 3. Touch the Targets subtab. 4. Touch Details to view target information, then touch Done.

3. Touch **Done** to return to the **Plate** tab.

View, pause, or stop a run



Do any of the following actions during an instrument run.

- View real-time data and plots (see “View real-time data and plots on the instrument touchscreen” on page 46).
- Adjust the display of real-time plots (see “Adjust the display of real-time plots on the instrument touchscreen” on page 47).
 - Touch  or swipe left once to view real-time run method information or to edit the number of cycles.
 - Touch  or swipe left twice to view real-time data and plots.
- Pause or stop an instrument run (see “Pause or stop an instrument run” on page 47).

View real-time data and plots on the instrument touchscreen

1. In the instrument home screen, during an instrument run, touch  or swipe left twice.
2. Touch **Well details**.
3. Touch **Samples**, **Targets**, or **Tasks** to select a graphical representation of each selection.
4. Touch **Close** to return to the home screen.

Adjust the display of real-time plots on the instrument touchscreen

1. In the instrument home screen, during an instrument run, touch  or swipe left twice to view real-time data and plots.
2. Touch **Zoom**.
3. Touch  or  to zoom in or out.
4. Touch the arrows to pan left, right, up, or down on the graph.
5. Touch **Close** to return to the default view.

Pause or stop an instrument run

1. In the home screen, during an instrument run, touch  or swipe left once to view real-time run method information.
2. Stop or pause the run.
 - Touch **Stop Run**.
 - Touch **Pause**, then enter a pause temperature.
3. *(Optional)* After pausing a run, touch **Edit** to change the number of cycles.
4. *(Optional)* After pausing a run, touch **Unlock drawer** to access the plate.



CAUTION! PHYSICAL INJURY HAZARD. During instrument operation, the plate temperature can reach 100°C. If you want to access the plate during a run pause, enter room temperature as the pause temperature and allow the plate to cool to room temperature before handling.

Lock the touchscreen during a run

After you have started a run, you can lock the touchscreen so that other users cannot interfere with instrument operation.

Note: You must be signed-in to use this feature.

1. Lock the touchscreen.
 - a. In the home screen, touch  **My Profile**.
 - b. Touch **Lock Screen**, then touch **Lock**.
2. Unlock the touchscreen.
 - a. Touch anywhere on the touchscreen.
 - b. Touch the **PIN Code** field, then enter your PIN.

Note: The touchscreen automatically unlocks when the run is complete.

Transfer EDS files from the instrument home screen

1. In the home screen, when a run ends, touch **Transfer File**.
2. Select the data destination for the EDS file.
3. Navigate to and select a folder.
4. Touch **OK**.
5. Touch **Transfer**.

Note: Touch  **Settings** ▶ **Run History** to transfer EDS files at any time.

5

Calibrate and verify instrument performance

- Calibration and verification schedule 49
- Calibration descriptions 50
- View the calibration status and set reminders 51
- Perform ROI/uniformity, background, and dye calibrations 52
- Perform instrument verification using RNase P plates 57
- Calibrate custom dyes 62
- Calibrate for a custom melt curve experiment 68

Calibration and verification schedule

The instrument is factory-calibrated and does not require calibration at installation. To ensure optimal performance, perform calibrations at the recommended frequency.

Note: After instrument installation, we recommend performing instrument verification using the provided RNase P plate.

IMPORTANT! Perform calibrations and instrument runs under the environmental conditions that are specified in “Environmental requirements” on page 89. Exposure to extreme temperatures can adversely affect the instrument performance and shorten the life span of the instrument components.

To set the calibration frequency for the instrument, touch **⊗ Settings ▶ Maintenance and Service ▶ Calibrations ▶ History and Reminders ▶ Edit ▶ Exp interval field.**

Calibration	Recommended frequency
ROI/Uniformity	<ul style="list-style-type: none"> • Every two years (recommended) • Always perform new Background and Dye calibrations after an ROI/Uniformity calibration. <p>Note: Performing an ROI/Uniformity calibration invalidates all other calibrations.</p>

Calibration	Recommended frequency
Background	<ul style="list-style-type: none"> • Every two years (recommended) • Background calibration can also be performed, as needed: <ul style="list-style-type: none"> – To check for contamination (depends on usage and laboratory conditions). – To obtain the most accurate data for the removal of background fluorescence. <p>Note: Performing a Background calibration does <i>not</i> invalidate any other calibration.</p>
Dye	<ul style="list-style-type: none"> • Every two years (recommended) • During a Dye calibration, only the dyes on the given spectral calibration plate are calibrated. <p>Note: Performing a Dye calibration for a given dye plate does <i>not</i> invalidate any other calibration.</p>
RNase P instrument verification	<ul style="list-style-type: none"> • After installing or moving the instrument • After performing instrument calibrations • As needed to confirm instrument performance

Note: To prepare custom dye plates and to perform custom calibrations, see “Calibrate custom dyes” on page 62.

Calibration descriptions

Calibration description and purpose	Pass Criteria
ROI/Uniformity	
<ul style="list-style-type: none"> • The software captures images for each optical filter. • The software uses calibration data to map the increase in fluorescence to the plate wells during subsequent runs and to evaluate well-to-well consistency of the signals. 	<p>The image for each filter distinguishes all wells of the plate.</p> <p>Each well in the image is distinct.</p>
Background	
<ul style="list-style-type: none"> • The software captures background images for each optical filter in the absence of sample and reagent, and it checks that the fluorescence from each well is below a fluorescence threshold. • The software uses calibration data to remove background fluorescence during a run. <p>Note: You can also run this calibration to determine if contamination is related to the sample block or the plate.</p>	<p>The plate images for all filters are free of abnormal fluorescence.</p>

Calibration description and purpose	Pass Criteria
Dye	
<ul style="list-style-type: none"> The software extracts a spectral profile for each dye standard, then produces a set of spectral profiles plotted as fluorescence vs filter. The software uses calibration data to characterize and distinguish the individual contribution of each dye in the total fluorescence signals collected by the instrument. 	Dye spectra peak within the same filter as their group.

View the calibration status and set reminders

View calibration status and set reminders in the instrument

- In the home screen, touch  **Settings** ▶ **Maintenance and Service** ▶ **Calibrations** ▶ **History and Reminders**.
- In the **Calibration Reminders** screen, view the status of each calibration type.
- (Optional)* Touch a calibration row to view the history of that specific calibration type, then touch **Done**.
- Touch **Edit** to set the calibration reminder settings. For each calibration type:
 - Slide the control **On** to enable the calibration reminder.
 - Edit the **Exp interval** and **Remind me** fields.
 - Touch **Save**.
- (Optional)* To transfer the calibration report, touch **Export** then follow the directions on the screen.
- Touch **Done**.

View calibration status and set reminders in the Cloud

Note: The calibration reminders feature requires a connection between the instrument and a computer network.

- In the Thermo Fisher Cloud, click  for the **Instrument Connect** page.
- Select any of your registered instruments.
- In the **Summary** tab:
 - Click **+ Calibrations** to view the status of each calibration type.
 - (Optional)* Click **+ Calibration Reminders** to set the calibration reminder time table and enter the notification email address(es).

Note: More than one email address can receive the calibration reminders.

Note: The settings are automatically saved.
 - (Optional)* In the **Downloads** section, click **Maintenance Summary.pdf** to download the calibration status report.

4. In the **Calibrations History** tab:
 - View the history of each calibration type.
 - (Optional) Click  to download the calibration history report.

Perform ROI/uniformity, background, and dye calibrations

Workflow: Calibration

Perform an ROI/uniformity calibration

You are automatically prompted to perform background calibration.



Perform a background calibration

Perform any time that ROI/uniformity calibrations are current.



Perform system dye calibrations

Perform any time that ROI/uniformity and background calibrations are current.



(Optional) Perform custom dye calibrations (“Calibrate custom dyes” on page 62)

Perform any time that ROI/uniformity and background calibrations are current.

Prepare a calibration plate

Materials required for calibration plate preparation

- Plate(s) for the calibration that you are performing:
 - ROI/Uniformity plate (one ROI plate needed)
 - Background calibration plate
 - Dye calibration plates

Note: We recommend calibrating with all Spectral Dye Calibrations Plates available for your block configuration even if you are not using all the dyes in the plates.

Note: Do not discard the packaging for the calibration plates. Each calibration plate can be used up to 3 times if the following conditions are met:

- The plate is stored in its packing sleeve at -15 to -25°C .
- The plate is used within 6 months after opening.
- The plate is used before the plate expiry date
- Centrifuge with plate adapter; buckets cleaned before use
- Powder-free gloves
- Safety glasses

Thaw, vortex, and centrifuge a calibration plate

1. Remove the calibration plate from the freezer, then thaw the plate in its packaging. Keep plates protected from light until you perform the calibration.
 - Thaw each plate for 30 minutes.
 - Use each plate within 2 hours of thawing.

IMPORTANT! Do not remove the plate from its packaging until you are ready to use it. The fluorescent dyes in the wells of calibration plates are photosensitive. Prolonged exposure to light can diminish the fluorescence of the dyes.

2. While wearing powder-free gloves, remove the calibration plate from its packaging and retain the packaging. Do not remove the optical film.
3. Vortex the plate for 5 seconds, then centrifuge at 750–1,000 × g for 2 minutes.
4. Confirm that the liquid in each well is at the bottom of the well and free of bubbles. If it is not, centrifuge the plate again.

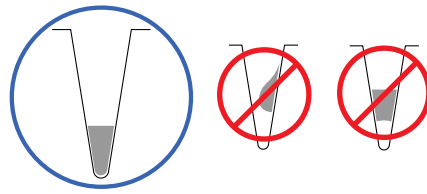

IMPORTANT! Keep the bottom of the plate clean. Fluids and other contaminants on the bottom of the plate can contaminate the sample block and cause an abnormally high background signal.

Perform calibrations

1. In the home screen, select a calibration to perform.

Calibration	Touch
ROI/Uniformity ^[1]	⚙️ Settings ▶ Maintenance and Service ▶ Calibrations ▶ ROI and Uniformity
Background ^[2]	⚙️ Settings ▶ Maintenance and Service ▶ Calibrations ▶ Custom ▶ Background
Dye	⚙️ Settings ▶ Maintenance and Service ▶ Calibrations ▶ Dye

^[1] Automatically followed by Background calibration.

^[2] Initiate via this route if performing Background calibration only.

2. Follow the instructions on the screen to start the calibration.

Note: *Dye calibration only:* Select the **Dye Plate** to run, then touch **Next**.
3. Load the plate into the instrument.
4. Touch **Start**.

5. When the run is complete and the screen displays **Calibration Complete**, touch **View Results** to check the calibration status.

Calibration status	Action
Passed	Touch Next to proceed to the next required calibration.
Failed	See “Troubleshoot calibration failure” on page 55.

Note: You can view the calibration images only after the ROI/Uniformity and Background calibrations pass.

6. Unload the plate from the instrument.



CAUTION! PHYSICAL INJURY HAZARD. During instrument operation, the plate temperature can reach 100°C. Allow it to cool to room temperature before handling.

7. Return the plate to its original packaging.

Note: Each calibration plate can be used up to 3 times if the following conditions are met:

- The plate is stored in its packing sleeve at –15 to –25°C.
- The plate is used within 6 months after opening.
- The plate is used before the plate expiry date

View calibration images and transfer results to USB

The instrument performs the ROI, Uniformity, and Background calibrations in sequence. You can view the calibration images after the Background calibration is complete.

1. In the **Calibration Status** screen, touch **Details**.
2. In the **Details** screen, touch a calibration type to view its images and plots.

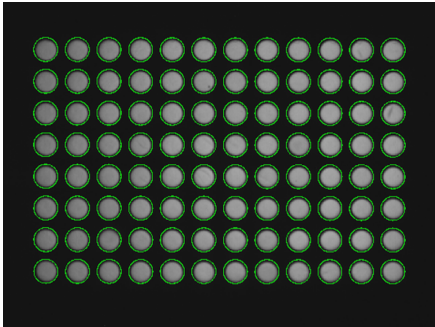
Calibration	Example results indicating successful calibration
ROI Note: Select the desired filter combination from the Filter Set dropdown list.	Green circles around all wells and bright well centers. 

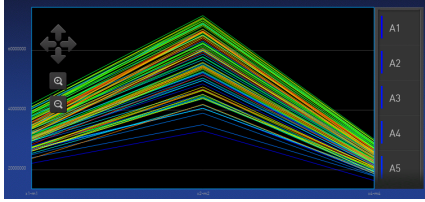
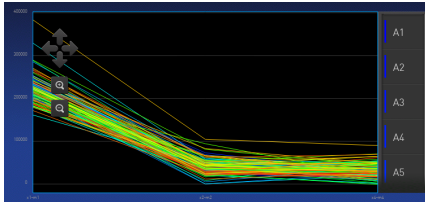
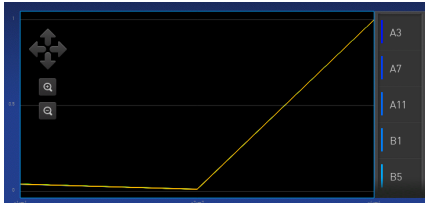
Calibration	Example results indicating successful calibration
Uniformity	<p>Signals from each well following a uniform trend.</p> 
Background	<p>Few, if any, signals with abnormally high fluorescence.</p> 
Dye	<p>Signals from each dye peaks at the correct filter.</p> 

- In the **Calibration Status** screen, touch **Accept Results** or **Reject Results**.
 Accepting the results saves the calibration data to the instrument and overwrites existing data.
- (Optional) Touch **Transfer EDS** to transfer the calibration data to a USB.

Troubleshoot calibration failure

Observation	Possible cause	Recommended action
Calibration failed	The plate was improperly prepared.	Ensure the following: <ul style="list-style-type: none"> The correct plate was used for the calibration performed. The plate was properly thawed. The plate was properly centrifuged. The plate was properly sealed.
	The plate is damaged or contaminated.	Check for damage, improper plate seal, or contamination.
		Order a replacement plate. If the replacement plate fails, contact Support.

Observation	Possible cause	Recommended action
High fluorescence signal in individual wells	Signals that exceed the limit of normal fluorescence may indicate fluorescent contaminants on the plate or the sample block.	See "Identify contamination" on page 56.
Calibration failed but plate is undamaged	The incorrect plate was used for calibration performed.	Use the plate that matches the calibration performed.
	The plate was improperly prepared.	Repeat the calibration with the plate properly prepared.
		If the calibration fails again, order a replacement plate. If the replacement plate fails, contact Support.

Identify contamination

Signals that exceed the limit of normal fluorescence may indicate fluorescent contaminants on the calibration plate or the sample block. Common contaminants include ink residue from permanent pens, powder from disposable gloves, and dust.

1. View the calibration data and note the wells that failed the calibration.
2. Remove the plate from the instrument, rotate the plate 180°, then perform the calibration again.
3. Determine the location of the failed wells again as in step 1.

Position of failed wells	Action
Identical	The sample block is contaminated. Decontaminate the sample block (see page 71).
Reversed	The plate is contaminated. Discard the plate, then perform the calibration using a new calibration plate.

4. If the calibration fails after you decontaminate the sample block and replace the plate, contact Support.

Create a background plate (optional)

Whenever possible, use a background plate listed in Appendix D, "Parts and materials". These plates contain a buffer that accurately simulates the reagents used for PCR, and, therefore, produces high-quality calibration data.

If a background plate is not available, you can create one as described below.

Required materials:

- MicroAmp™ optical 96-well reaction plate
- Optical adhesive cover or optical flat caps
- Pipettor, 200-μL (with pipette tips)
- Powder-free gloves
- Safety glasses
- Deionized water

IMPORTANT! Wear powder-free gloves while creating the background plate.

1. Remove a reaction plate from its box and place it on a clean, dry surface.
2. Aliquot 50 µL of deionized water to each well of the reaction plate.
3. Seal the plate using an optical adhesive cover or optical flat caps.
4. Use the plate for background calibration.

Perform instrument verification using RNase P plates

Instruments are factory-calibrated, so calibration is not necessary for initial installation. However, perform instrument verification:

- After installation and before first use of the instrument.
- After performing instrument calibrations.
- As needed to confirm instrument performance.

The instrument requires valid ROI/uniformity, background, and dye calibrations to perform instrument verification.

Instrument verification description

Purpose	Description	Pass criteria
Confirms the performance of the instrument.	Quantifies the number of copies of the human RNase P gene in samples with known concentrations of the corresponding DNA template.	<p>The instrument passes performance specifications if the following inequality is true and the instrument successfully distinguishes between unknown populations A and B with a statistical confidence level of 99.7%.</p> $[[C_{tA}] - 3\{\sigma_{C_{tA}}\}] > [[C_{tB}] + 3\{\sigma_{C_{tB}}\}]$ <p>where:</p> <ul style="list-style-type: none"> • C_{tA} = Average C_t of unknown population A • $\sigma_{C_{tA}}$ = Standard deviation of unknown population A • C_{tB} = Average C_t of unknown population B • $\sigma_{C_{tB}}$ = Standard deviation of unknown population B

RNase P instrument verification plate

The RNase P plate contains the reagents necessary for the detection and quantitation of genomic copies of the human RNase P gene (a single-copy gene encoding the RNase moiety of the RNase P enzyme). Each well contains: PCR master mix, RNase P primers, FAM™ dye-labeled probe, and a known concentration of human genomic DNA template.

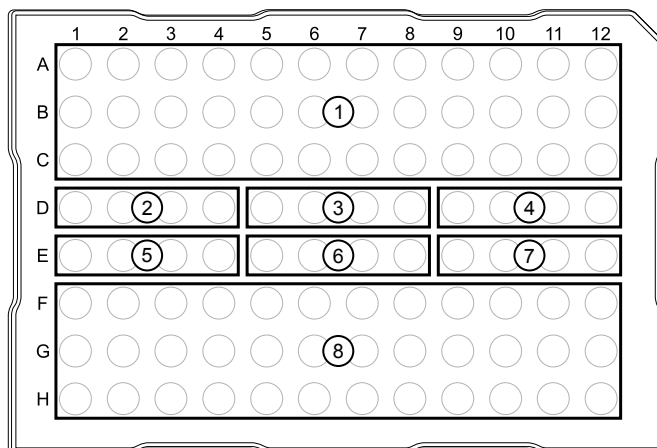

Figure 1 96-well RNase P plate

- | | |
|-----------------------------|----------------------|
| ① Unknown A (5,000) | ⑤ STD 5,000 copies |
| ② NTC (no template control) | ⑥ STD 10,000 copies |
| ③ STD 1,250 copies | ⑦ STD 20,000 copies |
| ④ STD 2,500 copies | ⑧ Unknown B (10,000) |

Performance specifications pass criteria

After the run, the software calculates average copy number values and standard deviation values. The instrument passes performance specifications if the following inequality is true and the instrument successfully distinguishes between unknown populations A and B with a statistical confidence level of 99.7%.

$$[(C_{tA}) - 3(\sigma_{CtA})] > [(C_{tB}) + 3(\sigma_{CtB})]$$

where:

- C_{tA} = Average C_t of unknown population A
- σ_{CtA} = Standard deviation of unknown population A
- C_{tB} = Average C_t of unknown population B
- σ_{CtB} = Standard deviation of unknown population B

The software automatically adjusts the threshold and omits a defined number of wells from the unknown populations to meet the performance specifications. To view any omitted wells, open the EDS file for the verification in the desktop software.

Prepare an RNase P plate

Materials required for RNase P plate preparation

- RNase P instrument verification plate
- Centrifuge with plate adapter; buckets cleaned before use
- Powder-free gloves
- Safety glasses

Thaw, vortex, and centrifuge an RNase P plate

IMPORTANT! Expose the RNase P plate to room temperature for no more than 45 minutes, inclusive of thawing and preparation time.

After thawing, the RNase P plate cannot be refrozen.

1. Remove the RNase P plate from the freezer, then thaw the plate in its packaging.
 - Thaw the plate for approximately 5 minutes.
 - Use the plate within 30 minutes of thawing.
2. Confirm that the bench, vortex, and centrifuge are clean. Before use, wipe the vortex and centrifuge using a lint-free tissue.
3. While wearing powder-free gloves, remove the plate from its packaging.
4. Vortex the plate for 5 seconds, then centrifuge at $750\text{--}1,000 \times g$ for 2 minutes.
5. Confirm that the liquid in each well is at the bottom of the well and free of bubbles. If it is not, centrifuge the plate again.

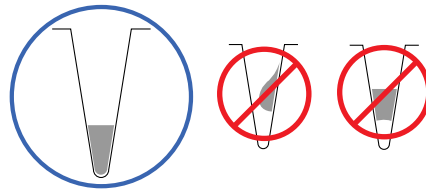

IMPORTANT! Keep the bottom of the plate clean. Fluids and other contaminants on the bottom of the plate can contaminate the sample block and cause an abnormally high background signal.

Perform RNase P verification

1. In the home screen, touch  **Settings** ▶ **Maintenance and Service** ▶ **RNase P Verification**.
2. Load the plate into the instrument.
3. Touch **Start**.
4. When the run is complete and the screen displays **Verification Complete**, touch **View Results** to confirm the status of the run.

Calibration status	Action
Passed	Instrument is ready for use.
Failed	See “Troubleshoot verification failure” on page 61.

5. In the **RNase P Verification Status** screen, touch one of the following options:
 - **Accept Results** — Save the results to the instrument.
 - **Reject Results** — Delete the RNase P verification results.
 - **Export Results** — Export the calibration results to a USB.
6. Unload the plate from the instrument.



CAUTION! PHYSICAL INJURY HAZARD. During instrument operation, the plate temperature can reach 100°C. Allow it to cool to room temperature before handling.

Troubleshoot verification failure

Observation	Possible cause	Recommended action
Verification failed	The plate was improperly prepared.	Ensure the following: <ul style="list-style-type: none"> • The correct plate was used for the verification performed. • The plate was properly thawed. • The plate was properly centrifuged. • The plate was properly sealed.
		Open the EDS file for the verification in the desktop software or cloud software to view the flags and troubleshooting details for failed wells.
	The plate is damaged or contaminated.	Check for damage, improper plate seal, or contamination.
		Order a replacement plate. If the replacement plate fails, contact Support.
High fluorescence signal	The reaction volume is not correct.	Ensure that reaction volumes in the plate are correct and match the volume that is entered in the Method tab.
	Signals that exceed the limit of normal fluorescence may indicate fluorescent contaminants on the plate or the sample block.	Examine the bottom of the reaction plate. If there is contamination, prepare a new plate and run the experiment again.
		Identify the location of contamination on the plate or sample block. <ol style="list-style-type: none"> 1. Obtain or prepare a background plate (see page 56). 2. Follow the procedures that are described in “Identify contamination” on page 56.
Verification failed but plate is undamaged	The incorrect plate was used for verification.	Use the correct RNase P plate for verification.
	The plate was improperly prepared.	Repeat the verification with a new properly prepared plate. Note: The verification procedure is an experiment run, so each RNase P plate can only be used once.
		Open the EDS file for the verification in the desktop software or cloud software to view the flags and troubleshooting details for failed wells.
		If the verification fails again, order a replacement plate. If the replacement plate fails, contact Support.

Calibrate custom dyes

Custom dyes overview

The instrument can run assays designed with custom dyes. Custom dyes include:

- Dyes that are not manufactured by Thermo Fisher Scientific.
- Dyes or formulations of dyes that are not system dyes for the instrument.
- For custom dye requirements, see “Custom dyes” on page 10.

Workflow: Custom dye calibration

For each custom dye, determine the optimal dye concentration. Use this concentration to prepare all subsequent dye calibration plates.

Use a dilution series to determine an optimal custom dye concentration

“Prepare a custom dye dilution plate” on page 63



“Run the dilution plate as an experiment” on page 64



“Determine the optimal dye concentration” on page 64



Calibrate the custom dye using the optimal concentration

Create a custom dye calibration plate



Add a custom dye to the instrument



“Perform a custom dye calibration” on page 66

Use a dilution series to determine an optimal custom dye concentration

Custom dye dilution guidelines

Prepare a dilution series for each custom dye.

- Target several dye concentrations within a range of 100–2,000 nM.
- Choose a 2- or 3-fold difference in dilution points.
- Dispense 10–20 μ L per well in a 96-well plate.
- Dilute the dye in buffer compatible with your master mix.
- (*Intercalating dyes only*) Add the appropriate amount of amplified PCR product to generate fluorescence.

Prepare a custom dye dilution plate

IMPORTANT! Wear powder-free gloves throughout the procedure.

1. Prepare a 2- or 3-fold dilution series of the custom dye.
2. Dispense aliquots of each dilution into the center of a reaction plate, then seal the plate.

A full plate is not needed. See the following figure for suggested replicates.

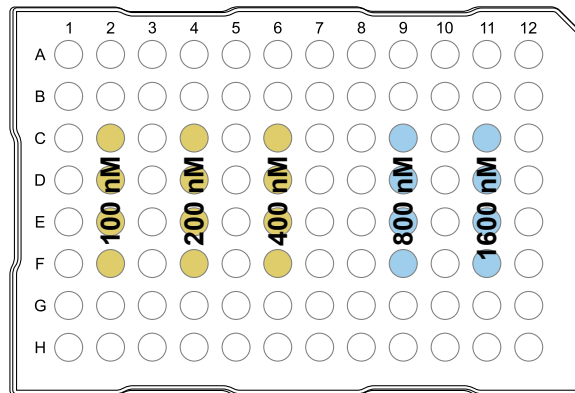

3. Vortex the plate for 5 seconds, then centrifuge at $750\text{--}1,000 \times g$ for 2 minutes.
4. Confirm that the liquid in each well is at the bottom of the well and free of bubbles. If it is not, centrifuge the plate again.

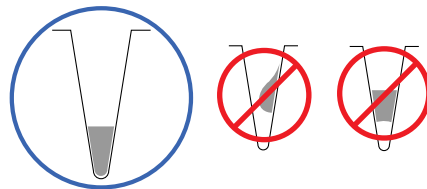

IMPORTANT! Keep the bottom of the plate clean. Fluids and other contaminants on the bottom of the plate can contaminate the sample block and cause an abnormally high background signal.

Run the dilution plate as an experiment

1. Load the plate into the instrument.
2. Set up a genotyping experiment on the instrument.
 - Load an experiment created in the desktop software.
 - a. In the home screen, touch **Load Experiment**.
 - b. Select the experiment location, then the experiment file.
 - Create a new experiment on the instrument touchscreen.
 - a. In the home screen, touch **Open Template** ▶ **Genotyping** ▶ **Genotyping Post**.
 - b. *(Optional)* In the **Properties** tab, edit the experiment properties.
 - c. In the **Method** tab, set the hold temperature to 60°C with a 2 minute hold and enter the appropriate reaction volume.
 - d. In the **Plate** tab, enter the dilution series information for the appropriate wells.
3. Touch **Start Run**.
4. When the run is complete, download the results for analysis.
5. Unload the plate from the instrument.



CAUTION! PHYSICAL INJURY HAZARD. During instrument operation, the plate temperature can reach 100°C. Allow it to cool to room temperature before handling.

Determine the optimal dye concentration

Review the dye signal data and select the dilution to use for dye calibrate.

1. In the **Results** tab of the desktop software, select **Raw Data Plot**.

This plot displays the raw fluorescence signal of each optical filter, for individual wells.

Note: The **Raw Data Plot** cannot be viewed on the instrument touchscreen.
2. For each replicate population of dilutions, select the wells in the **Plate Layout** to view in the plot.
3. Examine the raw data to identify the wells yielding signals in the 800,000 to 3,200,000 range for the optical filter where the dye is brightest.
4. *(Optional)* Export the raw data, then calculate the average fluorescence value for each concentration.
5. Select the lowest (optimal) dye concentration that falls within the acceptable signal range.

Calibrate the custom dye

Create a custom dye calibration plate

IMPORTANT! Wear powder-free gloves while creating the dye plate.

Create a full plate of the custom dye diluted to the optimal concentration:

1. Dilute the custom dye to the optimal concentration in buffer.
Prepare an adequate volume, using a volume range of 10–20 μL /well for a 96-well plate.
2. Pipet the appropriate volume of the diluted custom dye to the plate wells.
3. Seal the plate.
4. Vortex the plate for 5 seconds, then centrifuge at $750\text{--}1,000 \times g$ for 2 minutes.
5. Confirm that the liquid in each well is at the bottom of the well and free of bubbles. If it is not, centrifuge the plate again.

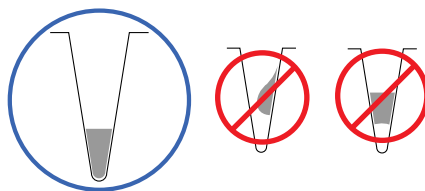

IMPORTANT! Keep the bottom of the plate clean. Fluids and other contaminants on the bottom of the plate can contaminate the sample block and cause an abnormally high background signal.

Add a custom dye to the instrument

1. In the instrument home screen, touch **⊗ Settings** ▶ **Maintenance and Service** ▶ **Calibrations** ▶ **Custom** ▶ **Custom Dye**.
2. Touch **Add Custom Dye**.

3. Enter the dye information:

Field/option	Action
Custom Dye Name	Enter a name for the custom dye. IMPORTANT! <ul style="list-style-type: none"> • Do not use a system dye name for a custom dye name. • Dye names are spacing sensitive and cannot contain special characters.
Type	Select: <ul style="list-style-type: none"> • Reporter—The dye works in conjunction with a quencher dye to report an increase of PCR product. • Quencher—The dye suppresses the fluorescence of a reporter dye until amplification of PCR product. • Both—The dye can be used as a reporter or quencher dye.

4. Touch **Save**.

IMPORTANT! You must also add the custom dye to the desktop software dye library before creating, running, or analyzing experiments that use custom dyes. For detailed information, see the QuantStudio™ Design and Analysis Software help.

Perform a custom dye calibration

1. Load the plate into the instrument.
2. In the instrument home screen, touch **⊗ Settings ▶ Maintenance and Service ▶ Calibrations ▶ Custom ▶ Custom Dye**.
3. Touch the custom dye to calibrate.
4. Review the custom dye information, (*optional*) make changes, then touch **Update**.
5. Enter the calibration temperature.
6. (*Optional*) Touch **Reagents**, then enter reagent information.
7. Touch **Start**.
8. When the run is complete and the screen displays **Calibration Complete**, touch **View Results ▶ Details**.

9. Review the plot. Passing calibration results show uniform signals with peaks that are aligned with the dye wavelength.

Peak filter	Filter wavelength (nm) ^[1]	
	Excitation	Emission
x1-m1	470 ± 15	520 ± 15
x2-m2	520 ± 10	558 ± 12
x4-m4	580 ± 10	623 ± 14

^[1] The central wavelengths are the optimized wavelengths.

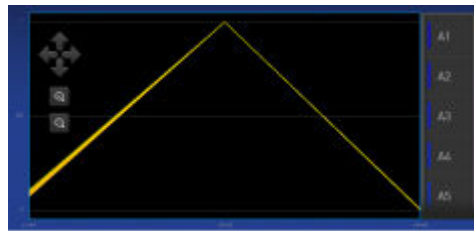

Figure 2 Example dye calibration plot

Note: The peaks for your dye may align with a different filter set.

10. Select an action depending on whether the custom dye calibration passed or failed.

Calibration status	Action
Passed	<ul style="list-style-type: none"> Touch Accept Results or Reject Results. <p>Note: Accepting the results saves the calibration data to the instrument and overwrites existing data.</p> <ul style="list-style-type: none"> { <i>Optional</i> } Touch Transfer EDS to transfer the calibration data to a USB.
Failed	<ul style="list-style-type: none"> Perform the calibration again using a new custom dye plate. Create the plate using the next dye concentration greater than the optimal dye concentration determined in "Use a dilution series to determine an optimal custom dye concentration" on page 62 See "Troubleshoot calibration failure" on page 55.

11. Unload the plate from the instrument.



CAUTION! PHYSICAL INJURY HAZARD. During instrument operation, the plate temperature can reach 100°C. Allow it to cool to room temperature before handling.

Calibrate for a custom melt curve experiment

Note: A custom melt calibration calibrates a custom dye and a melt calibration at the same time.

Before running the custom melt calibration complete the following tasks:

- Ensure that all calibrations are current (touch **⊛ Settings** ▶ **Maintenance and Service** ▶ **Calibrations** ▶ **History and Reminders**).
 - Add a custom dye to the instrument (see “Add a custom dye to the instrument” on page 65).
1. In the home screen, touch **⊛ Settings** ▶ **Maintenance and Service** ▶ **Calibrations** ▶ **Custom** ▶ **Custom Melt**.
 2. Touch **PCR + Melt** or **Melt only** as appropriate for the kit you are using.
 3. Load the plate into the instrument.
 4. Select or add a dye, then select a filter set appropriate for your dye's wavelength (see filter-wavelength table below).

Note: Refer to your reagent kit documentation for dye name and wavelength information.

Peak filter	Filter wavelength (nm) ^[1]	
	Excitation	Emission
x1-m1	470 ± 15	520 ± 15
x2-m2	520 ± 10	558 ± 12
x4-m4	580 ± 10	623 ± 14

^[1] The central wavelengths are the optimized wavelengths.

IMPORTANT! If the selected filter set does not match your reagent kit documentation, then the incorrect wavelength may be collected during a run.

5. (Optional) Touch **Reagents**, then enter reagent information.
6. Touch **Start**.
7. When the run is complete and the screen displays **Calibration Complete**, touch **View Results** ▶ **Details**.

- Review the plot. Passing calibration results show uniform signals with peaks that are aligned with the dye wavelength.

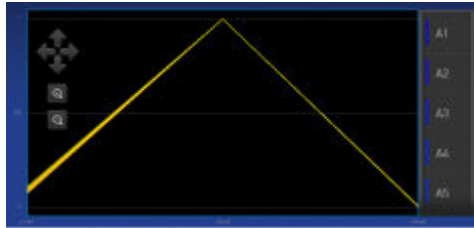

Figure 3 Example dye calibration plot

Note: The peaks for your dye may align with a different filter set.

- Select an action depending on whether the custom dye calibration passed or failed.

Calibration status	Action
Passed	<ul style="list-style-type: none"> Touch Accept Results or Reject Results. Note: Accepting the results saves the calibration data to the instrument and overwrites existing data. <i>[Optional]</i> Touch Transfer EDS to transfer the calibration data to a USB.
Failed	<ul style="list-style-type: none"> Perform the calibration again using a new custom dye plate. Create the plate using the next dye concentration greater than the optimal dye concentration determined in “Use a dilution series to determine an optimal custom dye concentration” on page 62 See “Troubleshoot calibration failure” on page 55.

- Unload the plate from the instrument.

Note:

- You must also add the custom dye to the QuantStudio™ Design and Analysis Desktop Software dye library before creating, running or analyzing experiments that use custom dyes.
- To perform a custom melt experiment, you can either create a Standard Curve or a Custom experiment with melt, then specify the data points per degree in the method.

6

Maintain the instrument

- Backup or restore the instrument 70
- Decontaminate the sample block 71
- Replace the instrument fuses 73
- Prepare the instrument to store, move, or ship 74

IMPORTANT! This chapter contains user maintenance procedures for the instrument. Procedures other than those described in this document must be performed by a qualified Thermo Fisher Scientific service representative.

Backup or restore the instrument

In the home screen, touch  **Settings** ▶ **Maintenance and Service** ▶ **Backup/Restore**.

To	Action
Backup	<ol style="list-style-type: none"> 1. Touch Backup Instrument. 2. Select a location to store the backup settings for your instrument. 3. If backing up to a USB, insert a USB into the front-panel USB port. 4. Enter a backup file name, then touch Done. 5. Select the elements to backup, or leave them all selected. 6. Touch Backup.
Restore (Administrator only)	<ol style="list-style-type: none"> 1. Touch Restore a Backup. 2. Select the storage location of the backup settings. 3. If restoring from a USB, insert a USB into the front-panel USB port. 4. Select the backup file, then touch Restore.

Decontaminate the sample block

Perform this procedure to eliminate fluorescent contaminants from the instrument sample block. Contamination is generally evident in failed background calibrations where one or more wells consistently exhibit abnormally high signals.



CAUTION! PHYSICAL INJURY HAZARD. Do not remove the instrument cover. There are no components inside the instrument that you can safely service yourself. If you suspect a problem, contact Support.



CAUTION! PHYSICAL INJURY HAZARD. During instrument operation, the sample block temperature can reach 100°C. Allow it to cool to room temperature before handling.



CAUTION! Before using a cleaning or decontamination method other than those recommended by Thermo Fisher Scientific, confirm with Thermo Fisher Scientific that the proposed method will not damage the equipment.

Materials required

- Safety glasses
- Powder-free gloves
- Tissue, lint-free
- Cotton or nylon swabs and lint-free cloths
- Pipette (100- μ L) with pipette tips
- Deionized water
- Ethanol, 95% solution
- Bleach, 10% solution

Clean the sample block



CAUTION! PHYSICAL INJURY HAZARD. During instrument operation, the sample block temperature can reach 100°C. Allow it to cool to room temperature before handling.

IMPORTANT!

- Wear powder-free gloves when you perform this procedure.
 - Always use deionized water to rinse wells after cleaning with bleach or ethanol solution.
-

1. Identify the contaminated wells of the sample block (see “Identify contamination” on page 56).
2. Prepare the instrument and access the sample block.
 - a. Power off and unplug the instrument, then allow it to cool for 15 minutes.
 - b. Pull the instrument drawer forward to expose the sample block.

3. Rinse the contaminated wells with deionized water (see “Detailed procedures for cleaning the sample block” on page 73).

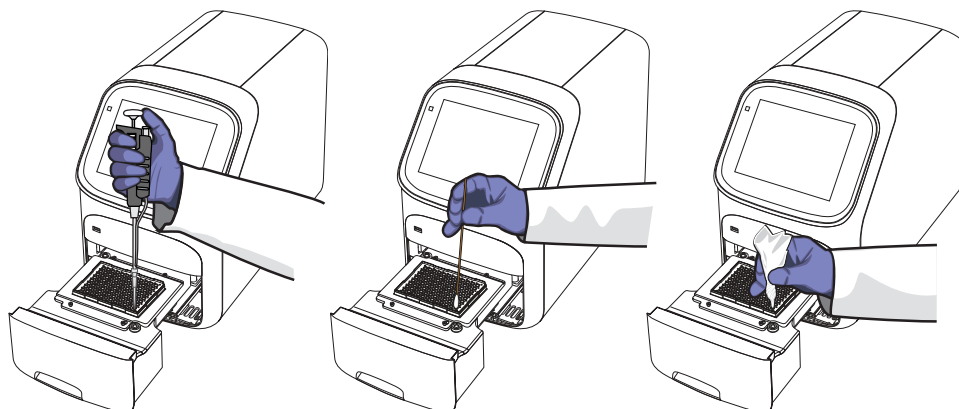

4. Close the drawer and test the sample block for contamination.
 - a. Push the instrument drawer back in to the instrument.
 - b. Plug in, then power on the instrument.
 - c. Perform a background calibration to confirm that you have eliminated the contamination.
5. If the contamination remains, clean the contaminated wells using a 95% ethanol solution.
 - a. Repeat step 2 – step 3.
 - b. Clean the contaminated wells using a 95% ethanol solution (see “Detailed procedures for cleaning the sample block” on page 73).
 - c. Repeat step 3 – step 4 to rinse the sample block with deionized water and to confirm that you have eliminated the contamination.

IMPORTANT! Always use deionized water to rinse wells after cleaning with bleach or ethanol solution.

6. If the contamination remains, clean the contaminated wells using a 10% bleach solution.
 - a. Repeat step 2 – step 3.
 - b. Clean the contaminated wells using a 10% bleach solution (see “Detailed procedures for cleaning the sample block” on page 73).
 - c. Repeat step 3 – step 4 to rinse the sample block with deionized water and to confirm that you have eliminated the contamination.

IMPORTANT! Always use deionized water to rinse wells after cleaning with bleach or ethanol solution.

7. If the contamination continues to remain, contact Support.

Detailed procedures for cleaning the sample block

IMPORTANT! Use these cleaning procedures *only* in conjunction with the complete decontamination procedure (see “Decontaminate the sample block” on page 71).

- Rinse the sample block with deionized water.
 - a. Pipet a small volume of deionized water into each contaminated well.
 - b. In each well, pipet the water up and down several times to rinse the well.
 - c. Pipet the water to a waste beaker.
 - d. Use a cotton swab to scrub inside of each contaminated well.
 - e. Use a lint-free cloth to absorb the excess deionized water.
- Clean the sample block with 95% ethanol.
 - a. Pipet a small volume of 95% ethanol solution into each contaminated well.
 - b. In each well, pipet the solution up and down several times to rinse the well.
 - c. Pipet the ethanol solution to a waste beaker.

IMPORTANT! Always use deionized water to rinse wells after cleaning with bleach or ethanol solution.

- Clean the sample block with 10% bleach.
 - a. Pipet a small volume of 10% bleach solution into each contaminated well.
 - b. In each well, pipet the solution up and down several times to rinse the well.
 - c. Pipet the bleach solution to a waste beaker.

IMPORTANT! Always use deionized water to rinse wells after cleaning with bleach or ethanol solution.

Replace the instrument fuses



CAUTION! FIRE HAZARD. For continued protection against the risk of fire, replace fuses only with listed and certified fuses of the same type and rating as those currently in the instrument.

Materials required



- Fuses (2) – 10A, Time-Lag T, 250VAC, 5 × 20mm
- Safety glasses
- Powder-free gloves
- Screwdriver, flathead

Replace the fuses

1. Power off and unplug the instrument, then allow it to cool for 15 minutes.
2. Using a flat-head screwdriver, unscrew and remove the fuse holder.



3. Remove each fuse from its fuse holder and inspect it for damage. Carbon typically coats the inside of failed fuses.

Good	Failed
	

4. Replace each failed fuse.
Note: The voltage and amperage ratings are on the fuse holder.
5. Install the fuse holder back into the instrument.
6. Plug in, then power on the instrument.
The installation is successful if the instrument powers on.

Note: Fuse failure can result from fluctuations in the supplied power to the system. To prevent further failures, consider installing an electrical protective device, such as a UPS or a surge protector. If issues with the fuse persist, contact Support.

Prepare the instrument to store, move, or ship

1. In the home screen, touch  **Settings** ▶ **Maintenance and Service** ▶ **Ship Prep Mode** ▶ **Next**.
2. Open the instrument drawer.
3. Load the packing plate or an empty plate, then close the drawer.
4. Touch **Lock Block**.
5. Power off the instrument using the power switch on the back of the instrument.

The instrument is now ready to store, move, or ship.

Move the instrument



CAUTION! PHYSICAL INJURY HAZARD. Do not attempt to lift the instrument or any other heavy objects unless you have received related training. Incorrect lifting can cause painful and sometimes permanent back injury. Use proper lifting techniques when lifting or moving the instrument. At least two people are required to lift it.

IMPORTANT! Moving your instrument can create subtle changes in the alignment of the instrument optics. Recalibrate the instrument if necessary.

- Ensure that the surface on which you place the instrument can support at least 35 kg (77 lbs).
- Ensure that the path to transport the instrument is clear of obstructions.
- At least two people are needed to lift and carry the instrument.
- Keep your spine in a good neutral position.
- Bend at the knees and lift with your legs.
- Do not lift an object and twist your torso at the same time.
- Coordinate your intentions with your assistant before lifting and carrying.

IMPORTANT! After moving the instrument, perform an RNase P instrument verification run. If the run fails, perform ROI/ uniformity, background, and dye calibrations.

Return the instrument for service

The service process requires 2 to 3 weeks.

Before returning the instrument for service, perform the following tasks.

1. Back up the instrument (see “Backup or restore the instrument” on page 70).
2. In the home screen, touch **Settings** ▶ **Instrument Settings** ▶ **Reset Factory defaults**.
3. Set the instrument to **Ship Prep Mode** (see “Prepare the instrument to store, move, or ship” on page 74).

To return the instrument for service, perform the following tasks.

1. Contact your local customer care center or technical support group to obtain a copy of the Certificate of Instrument Decontamination, a service notification, a service call number, and packaging materials (if required).

2. Follow the instructions in the form to decontaminate the instrument.

IMPORTANT! The instrument must be decontaminated before packing it for shipping.

3. Complete and sign a copy of the Certificate of Instrument Decontamination.
4. Fax the Certificate of Instrument Decontamination to the customer care center.

5. Pack the instrument in the provided packaging and follow the instructions in the table below.

Prepare	Include	Exclude
<ol style="list-style-type: none"> 1. Transfer any data files from the instrument. 2. Load an empty plate in the sample block. 3. Use the touchscreen to place the instrument in ship mode. <p>Note: The empty plate and ship mode protects the internal components of the instrument during transport.</p>	<ul style="list-style-type: none"> • Instrument • Completed and signed Certificate of Instrument Decontamination <p>Note: The instrument will not be accepted for service without a hard copy of the Certificate of Instrument Decontamination.</p>	<p>Any accessories, including:</p> <ul style="list-style-type: none"> • Power cord • Ethernet cable • USB drive • Wireless adapter <p>Note: If included with the instrument, these items will be disposed of during service and not returned.</p>

6. Attach the postage provided with the Certificate of Instrument Decontamination to the box, then ship the instrument to the designated facility.



Install and connect the instrument to a network

- Workflow: Install and connect to a network 77
- Before you begin 78
- Instrument and computer connections 78
- Unpack and install the instrument 79
- Power on and follow the startup wizard 80
- Connect the instrument and the computer directly or to a LAN 80
- Networking 81

Workflow: Install and connect to a network

Perform all steps in “Before you begin” on page 78



“Unpack and install the instrument” on page 79



“Power on and follow the startup wizard” on page 80



“Perform instrument verification using RNase P plates” on page 57



“Connect the instrument and the computer directly or to a LAN” on page 80

Before you begin

This section provides instructions for customer installation of the computer and the instrument. For installation by a field service engineer (FSE), contact Support to order a service call.

Before starting the installation, complete the following tasks:

- Determine the configuration for your instrument and obtain the network information you need (see “Networking” on page 81).
- Review site requirements (see *QuantStudio™ 1 Real-Time PCR System Site Preparation Guide* (Pub. No. MAN0017854).
- Review instrument and computer connections (see “Instrument and computer connections” on page 78).

Instrument and computer connections

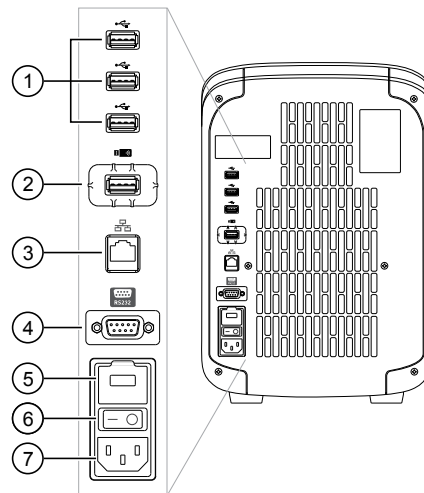

Figure 4 Instrument back panel

- | | |
|---|-----------------------------------|
| ① USB ports | ④ RS232 Port—For service use only |
| ② WiFi USB port—Connect USB wireless adapter for wireless network access [ordered separately] | ⑤ Fuse Cover |
| ③ Ethernet Port—RJ45 port for 100/1,000 Mbps Ethernet communication with the instrument | ⑥ Power Switch |
| | ⑦ Power Port—100 to 240 VAC |

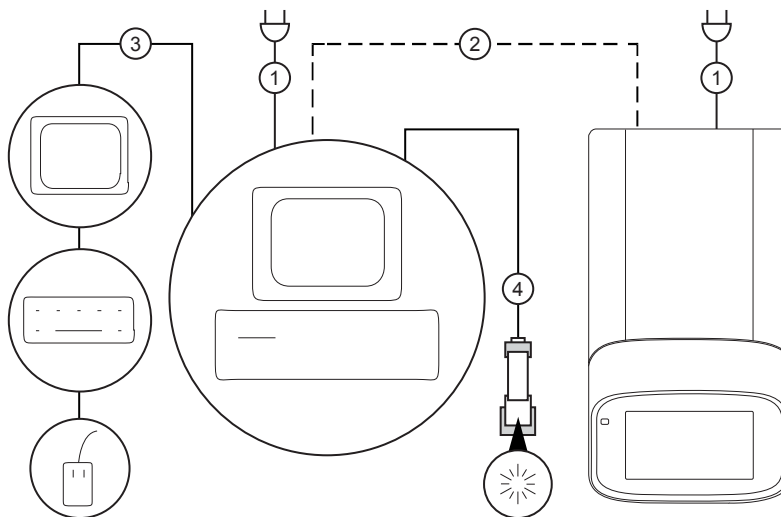

Figure 5 Instrument-to-computer connections (minitower configuration)

- ① Detachable power supply cord compatible with local power supply receptacle.
- ② Connection between the computer and the instrument.
- ③ Connection between the computer and the monitor, keyboard, and mouse.
- ④ Connection between the computer and the *optional* handheld barcode scanner.

Unpack and install the instrument

1. Prepare the installation site as described in the *QuantStudio™ 1 Real-Time PCR System Site Preparation Guide* (Pub. No. MAN0017854).
2. Follow the pre-printed instructions on the instrument box to unpack the instrument, accessories, and reference documentation. Save the packing material for future use or recycle it.

The instrument box contains:

- Reference documentation: Welcome note, unpacking and set up instructions card, system documentation insert
- One instrument
- Accessories: power cable, Ethernet cable, USB drive, reaction tube retainer
- Shipping plate

Note: Save the shipping plate but do not use it to operate the instrument.

If you ordered the wireless adapter, it is provided separately.

3. Place the instrument on the bench.
4. Plug the power cable into the power port on the back panel of the instrument, then plug the cable into an electrical receptacle.



5. Connect your instrument as required by your network configuration (see “Supported options for instrument and computer connections” on page 16 and “Instrument and computer connections” on page 78).
 - Connect an Ethernet cable to the Ethernet port on the back panel of the instrument, then connect the cable to a computer or a networking port.
or
 - Connect wirelessly via the wireless adapter.

Note: Do not connect the High Power USB WiFi Module (Cat. No. A26774) to the instrument if it is connected to a network by an Ethernet cable. Configuring the instrument for both wired and wireless connection can interfere with instrument operation.

Power on and follow the startup wizard

1. Power on the instrument.
2. Follow the startup wizard through the following tasks:
 - Select the language for the instrument.
 - Accept the license agreement.
 - Select a **Wired** or **Wireless** networking option, as needed for your configuration (see “Supported options for instrument and computer connections” on page 16).
 - Configure the instrument date and time.
 - Create an administrator instrument profile.

Note: You can perform any of the steps above at a later time if you do not have the information needed to complete the startup screens. See Chapter 3, “Configure the instrument and manage instrument profiles”.

IMPORTANT! Before using the instrument for the first time, we recommend that you perform instrument verification using RNase P plates (see “Perform instrument verification using RNase P plates” on page 57).

Connect the instrument and the computer directly or to a LAN

This section describes direct wired connection of the computer provided by Thermo Fisher Scientific to the instrument or to a LAN.

Do not connect a customer-provided computer to the instrument.

1. Connect an Ethernet cable from the instrument or a LAN to the computer.
2. Power on the computer, then log in using a Windows™ Administrator account.
3. In the Windows™ desktop, right-click **My Network Places ▶ Properties**.
4. Right-click **Local Area Connection**, then select **Properties**.



5. Select **Internet Protocol (TCP/IP) ▶ Properties**.
6. Set the Internet Protocol (TCP/IP) Properties for either DHCP or Static IP communication:

Network configuration	Action
DHCP	<ol style="list-style-type: none"> 1. Select Obtain an IP address automatically. 2. Set the DNS address. If the computer obtains DNS addresses: <ul style="list-style-type: none"> • Automatically – Select Obtain DNS server address automatically. • Statically – Select Use the following DNS address, then enter the address of the preferred and alternate DNS servers (if available).
Static IP	<ol style="list-style-type: none"> 1. Select Use the following IP address. 2. In the IP Address field, enter the static IP address. 3. If necessary, enter a subnet mask. 4. If necessary, enter a static gateway address in the Default Gateway field.

7. If your network requires advanced TCP/IP setup (such as WINS), define the settings:
 - a. Click **Advanced** in the Internet Protocol (TCP/IP) Properties dialog box.
 - b. Define the IP Settings, DNS, and WINS tabs as instructed by your systems administrator, then click **OK**.
8. Close all dialog boxes by clicking **OK**, then re-start the computer.
The computer is now visible to other computers on the network.

Networking

IMPORTANT! This section provides general networking information. It *does not* provide adequate detail to integrate the instrument into all possible network architectures. Because a network may contain advanced features (such as a firewall or network domains), we recommend that you consult a network administrator before connecting the instrument to your laboratory network.

Supported options for instrument and computer connections

We support the following direct, networked (LAN–local area network), or Cloud configurations. Configurations other than those listed are not recommended. Select a configuration that meets the needs of your laboratory's instrument, software, and workflow requirements.

IMPORTANT! Do *not* connect *both* an Ethernet cable and the Wi-Fi module (Cat. No. A26774) to the instrument. Configuring the instrument for both wired and wireless connection can interfere with instrument operation.

Note: For detailed information about networking your instrument, see the *QuantStudio™ 1 Real-Time PCR System IT Checklist* (Pub. No. MAN0018164).

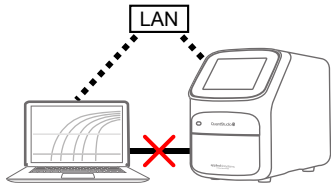
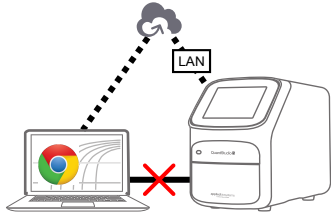
Direct configuration option	
<ul style="list-style-type: none"> A computer provided by Thermo Fisher Scientific with the QuantStudio™ Design and Analysis Desktop Software 	
<ul style="list-style-type: none"> Computer-to-instrument connection: <ul style="list-style-type: none"> Direct, wired connection between the computer and the instrument using an Ethernet cable <p>IMPORTANT! A direct instrument-to-computer connection <i>cannot</i> be combined with the LAN or the Cloud configurations.</p>	
Networked configuration option	
<ul style="list-style-type: none"> A computer provided by Thermo Fisher Scientific with the QuantStudio™ Design and Analysis Desktop Software The computer and instrument must be on the same subnet mask. 	
<ul style="list-style-type: none"> Computer-to-LAN connection <i>(select an option)</i>: <ul style="list-style-type: none"> Wired connection to the network using an Ethernet cable – or – Wireless connection to the network 	
<ul style="list-style-type: none"> Instrument-to-LAN connection <i>(select an option)</i>: <ul style="list-style-type: none"> Wired connection to the network using an Ethernet cable – or – Wireless connection to the network using the instrument Wi-Fi module 	
Thermo Fisher Cloud configuration option	
<ul style="list-style-type: none"> Internet access and a computer with the Chrome™ web browser to access the Cloud 	
<ul style="list-style-type: none"> Computer-to-Cloud connection <i>(select an option)</i>: <ul style="list-style-type: none"> Wired connection to the internet using an Ethernet cable – or – Wireless connection to the internet 	
<ul style="list-style-type: none"> Instrument-to-Cloud connection <i>(select an option)</i>: <ul style="list-style-type: none"> Wired connection to the network using an Ethernet cable – or – Wireless connection to the network using the instrument Wi-Fi module 	

Control and monitor networked instruments

When the instrument is connected to a network:

- Computers on the network that are running the desktop software can control the instrument. Networked instruments can be controlled by only one computer at a time.
- Instruments linked to the Cloud cannot be controlled remotely. However, you can:
 - Remotely access the cloud software to create (and analyze) experiments.
 - From the instrument, download the experiments and start a run.
 - Monitor a run from the Cloud in real time.



Ethernet port overview

The Ethernet port of the instrument supports:

- Static IP network service with subnet mask, primary and secondary data network service (DNS), and default gateway settings, or dynamic host configuration protocol (DHCP) network service.
- mDNS/DNS for local domains.

Note: Because mDNS is limited to direct network connections, an instrument configured for mDNS may not be visible to other nodes that are separated by a router, hub, or another network device.

- IPv4 linklocal (IPV4LL) in the RFC (also known as Automatic Private IP Addressing [APIPA] or Internet Protocol Automatic Configuration [IPAC]).

Note: When an instrument is set for DHCP, APIPA is automatically enabled, and the instrument provides an IP address when no address is supplied by the DHCP server.

Firewall ports that must be open

Ports	Condition
80/443	Standard ports for instrument-to-Cloud and computer-to-Cloud connections
mDNS, 7000	Instrument-to-computer connection
mDNS, 5353	Instrument discovery

Networking guidelines and best practices

- Consult a network administrator before connecting the instrument to a network.
- To enable the full functionality of the software, the computer requires a network connection.
- Open the firewall port for the instruments to be discovered. See “Firewall ports that must be open” on page 83.
- Observe the restrictions to mDNS and Autodiscovery.

The instrument supports mDNS but only when the instrument and computer share a direct network connection and are within the same subnet. Network computers that are separated from the instrument by a router, hub, or another network device may not be able to access the instrument by its host name.

- Confirm the uniqueness of the instrument name.
 - The instrument name must be unique within the subnet. The desktop software can automatically discover instruments on the link-local network.
 - The instrument does not test the uniqueness of the instrument name within the subnet when it is set.



Troubleshooting

Observation	Possible cause	Recommended action
Inconsistent communication between instrument and computer or instrument and Cloud	The instrument is configured for <i>both</i> wired and wireless network connection.	Ensure only one connectivity option is plugged into the instrument (either an Ethernet cable <i>or</i> a wireless adapter, but not both).
		Configure for wired <i>or</i> wireless network connection.
	Weak or unstable internet connection, especially if configured for wireless.	Change the configuration to a wired connection.
		Use a wireless network with a stronger or more consistent signal.
The connection between the instrument and the computer is not recognized	The connection is not fully established.	Power the instrument off, then power it on again.
	If using a networked configuration, the instrument and computer are not on the same subnet mask.	Contact your information technologies department to have them ensure that the instrument and computer are on the same subnet mask.
	If using a networked configuration, the instrument or computer has an invalid IP address.	Contact your information technologies department to have them ensure that the IP addresses are valid.
Insufficient disk space message	Insufficient disk space to save a run.	<ol style="list-style-type: none"> In the home screen, touch  Settings ▶ Run History ▶ Manage. Delete or transfer experiments from the instrument.
The touchscreen is black	The instrument is in sleep mode.	Touch anywhere on the instrument touchscreen.
	The instrument is not powered on.	If you touch the instrument touchscreen and it remains black, check if the instrument is powered on. The power switch is located on the rear panel of the instrument.
		If the instrument does not power on, check that the instrument is properly plugged in.
		If the instrument does not power on and the instrument is properly plugged in, contact Support.
Forgot PIN for instrument profile	Non-administrator forgot instrument profile PIN.	See “Manage all instrument profiles (Administrator only)” on page 37.
	Administrator forgot instrument profile PIN.	Have another administrator reset the PIN for the forgotten-PIN profile (see “Manage all instrument profiles (Administrator only)” on page 37).

Observation	Possible cause	Recommended action
Forgot PIN for instrument profile		If there is not another administrator profile on the instrument, you must restore factory defaults (see “Restore factory defaults” on page 34).
High fluorescence signal	The reaction volume is not correct.	Ensure that reaction volumes in the plate are correct and match the volume that is entered in the Method tab.
	Signals that exceed the limit of normal fluorescence may indicate fluorescent contaminants on the plate or the sample block.	Examine the bottom of the reaction plate. If there is contamination, prepare a new plate and run the experiment again.
		Identify the location of contamination on the plate or sample block. <ol style="list-style-type: none"> 1. Obtain or prepare a background plate (see page 56). 2. Follow the procedures that are described in “Identify contamination” on page 56.



Instrument specification and layout

■ Configured system dimensions	87
■ Electrical requirements	88
■ Environmental requirements	89
■ Network requirements	90

Configured system dimensions

Allow space for the configured instrument. A typical setup with a co-located minitower computer is shown below.

Note: Dimensions are rounded to the nearest whole or half unit.

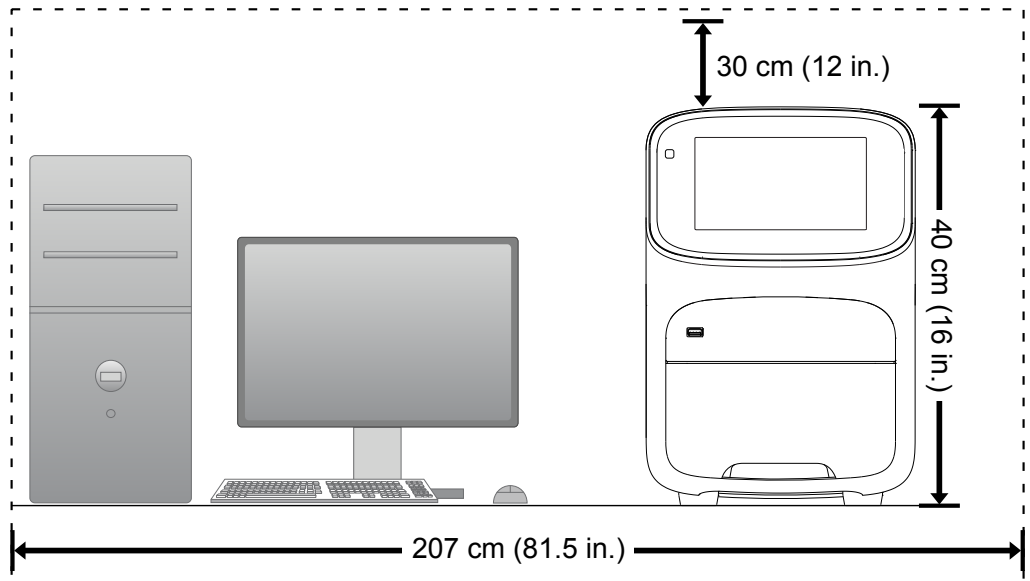
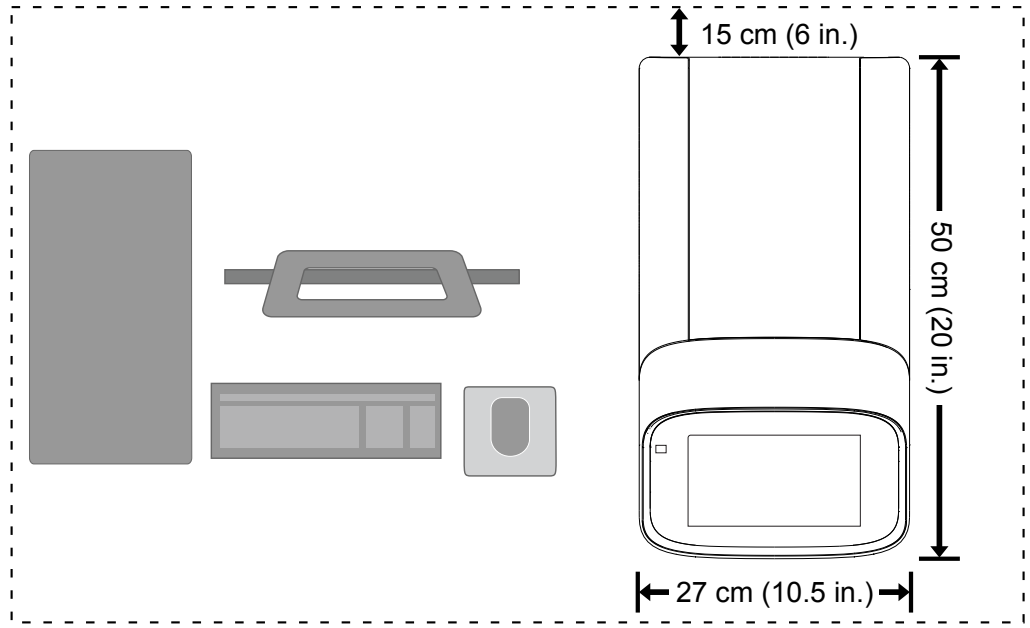



Instrument clearances

During instrument installation and maintenance, it is necessary to access the back of the instrument. If the back of the instrument faces a wall, ensure that there is sufficient clearance on the bench to rotate the instrument for access.

IMPORTANT! For safety, the power outlet for the instrument must be accessible.

Component	Top	Front	Sides	Back
Instrument	30 cm (12 in.)	30 cm (12 in.)	15 cm (6 in.)	15 cm (6 in.)
Computer ^[1]	—	15 cm (6 in.)	—	15 cm (6 in.)

^[1] Co-locating the computer with the instrument is optional.

Electrical requirements



WARNING! For safety, the power outlet used for powering the instrument must be accessible at all times. See “Instrument clearances” on page 88 for information about the space needed between the wall and the instrument. In case of emergency, you must be able to immediately disconnect the main power supply to all the equipment. Allow adequate space between the wall and the equipment so that the power cords can be disconnected in case of emergency.

- Electric receptacle with grounding capability
- Maximum power dissipation: ~960 W (not including computer and monitor)
- Mains AC line voltage tolerances must be up to ±10 percent of nominal voltage

Device	Rated voltage	Circuit required	Rated frequency	Rated power
Instrument	100–240 ±10% VAC ^[1]	10 A	50/60 Hz	750 W
Computer (laptop)	100–240 ±10% VAC	10 A	50/60 Hz	90 VA
Computer (desktop)	100–240 ±10% VAC	10 A	50/60 Hz	125 VA
Monitor				65 VA

^[1] If the supplied power fluctuates beyond the rated voltage, a power line regulator may be required. High or low voltages can adversely affect the electronic components of the instrument.



Environmental requirements

Table 3 Environmental requirements

Condition	Acceptable range
Installation site	Indoor use only
Electromagnetic interference	Do not use this device in close proximity to sources of strong electromagnetic radiation (for example, unshielded intentional RF sources). Strong electromagnetic radiation may interfere with the proper operation of the device.
Altitude	Between sea level and 2000 m (6500 ft.) above sea level
Operating conditions	<ul style="list-style-type: none"> Humidity: 15–80% relative humidity (noncondensing) Temperature: 15 to 30°C (59 to 86°F) <p>Note: For optimal performance, avoid rapid or extreme fluctuations in room temperature.</p>
Storage and transport conditions	<ul style="list-style-type: none"> Humidity: 20–80% relative humidity (noncondensing) Temperature: –30 to 60°C (–22 to 140°F)
Thermal output	During operation, the net thermal output, based on the actual current draw of the instrument, is expected to be approximately 960 W (3275 Btu/h).
Vibration	Ensure that the instrument is not adjacent to strong vibration sources, such as a centrifuge, pump, or compressor. Excessive vibration will affect instrument performance.
Pollution degree	<p>The instrument has a Pollution Degree rating of II. The instrument may only be installed in an environment that has nonconductive pollutants such as dust particles or wood chips. Typical environments with a Pollution Degree II rating are laboratories and sales and commercial areas.</p> <p>The noise output of the instrument is ≤ 60 dB when running.</p>
Other conditions	<p>Ensure the instrument is located away from any vents that could expel particulate material onto the instrument components.</p> <p>Avoid placing the instrument and computer adjacent to heaters, cooling ducts, or in direct sunlight.</p>



Network requirements

The instrument:

- Is factory-configured for IPv4 TCP/IP communication and includes an Ethernet adapter (100/1,000 Mbps) with an RJ45-type connector for integrating the device into a local area network (LAN).
- Can alternatively be configured for wireless networking (High Power USB WiFi Module required, sold separately as an optional accessory).

The instrument can be configured for *either* wired or wireless networking, not both.

If a Thermo Fisher Scientific service representative is to install the instrument:

- If the instrument will be connected to a LAN, an active, tested network jack must be in place before the scheduled installation date.
- A representative from your information technologies department must be available during the installation to help connect the instrument to your network.

Required materials to network the instrument:

- Wired—Ethernet cable of sufficient length with RJ45 connectors
 - CAT5 cable for a 100 Mbps network connection
 - CAT5e or CAT6 cable for a 1,000 Mbps network connection
- or–
- Wireless—High Power USB WiFi Module (Cat. No. A26774, sold separately)



Parts and materials

- Kits, consumables, accessories, and reagents 91
- Consumables (96-well, 0.2-mL format) 91
- Accessories 92
- General-use materials and consumables 92

Kits, consumables, accessories, and reagents

Unless otherwise indicated, all materials are available through thermofisher.com.

Store all calibration and RNase P plates at -20°C. All other items can be stored at 15–30°C. Use all materials by the expiration date on the packaging.

Consumables (96-well, 0.2-mL format)

Consumable	Amount	Cat. No.
MicroAmp™ Optical 8-Cap Strips	300 strips	4323032
MicroAmp™ Optical 8-Tube Strip, 0.2 mL	125 strips	4316567
MicroAmp™ Optical Tube without Cap, 0.2 mL	2,000 tubes	N8010933
MicroAmp™ Optical 96-Well Reaction Plate with Barcode	20 plates	4306737
	500 plates	4326659
MicroAmp™ EnduraPlate™ Optical 96-Well Clear GPLE Reaction Plates with Barcode	20 plates	4483348
	500 plates	4483351

Instrument verification or calibration plate	Cat. No.
TaqMan® RNase P Instrument Verification Plate, 96-Well 0.2-mL	4432382
Region of Interest (ROI) and Background Plates, 96-Well 0.2-mL (2 plates)	4432364
QuantStudio™ 3/5 Spectral Calibration Plate 1 ^[1] (FAM™, VIC™, ROX™, and SYBR™ dyes), 96-Well 0.2-mL	A26331
QuantStudio™ 3/5 Spectral Calibration Plate 2, 96-Well 0.2-mL ^[1] (ABY™, JUN™, and MUSTANG PURPLE™ dyes)	A26332

^[1] Compatible with QuantStudio™ 1 Real-Time PCR System.

Accessories

Item	Amount	Cat. No.
MicroAmp™ 96-Well Tray/Retainer Set	10 trays	4381850
MicroAmp™ Multi Removal Tool	1 tool	4313950
MicroAmp™ Cap Installing Tool (handle style)	1 tool	4330015
MicroAmp™ Optical Adhesive Film	25 films	4360954
	100 films	4311971
MicroAmp™ Adhesive Film Applicator	5 applicators	4333183
RT-PCR Grade Water	10 × 1.5 mL tubes	AM9935
Handheld Barcode Scanner	1 scanner	4488442
High Power USB WiFi Module	1 module	A26774

General-use materials and consumables

The following general-use materials and consumables are required to calibrate, maintain, and operate the instrument. Unless otherwise indicated, all materials are available through thermofisher.com. MLS: Fisher Scientific (fisherscientific.com) or other major laboratory supplier.

Material/Consumable	Source
Bleach, 10% solution	MLS
Centrifuge with 96-well plate buckets	MLS
Cotton or nylon swabs and lint-free cloths	MLS
Ethanol, 95% solution	MLS
Optical clear adhesive film for PCR	MLS
Pipettors, 100- μ L and 200- μ L (with pipette tips)	MLS
Powder-free gloves	MLS
Safety glasses	MLS
Screwdriver, flathead	MLS
Tissue, lint-free	MLS
Deionized water	MLS



Safety

■ Symbols on this instrument	94
■ Safety alerts on this instrument	96
■ Safety information for instruments not manufactured by Thermo Fisher Scientific	97
■ Instrument safety	97
■ Safety and electromagnetic compatibility (EMC) standards	98
■ Chemical safety	100
■ Biological hazard safety	101







 **WARNING! GENERAL SAFETY.** Using this product in a manner not specified in the user documentation may result in personal injury or damage to the instrument or device. Ensure that anyone using this product has received instructions in general safety practices for laboratories and the safety information provided in this document.



- Before using an instrument or device, read and understand the safety information provided in the user documentation provided by the manufacturer of the instrument or device.
 - Before handling chemicals, read and understand all applicable Safety Data Sheets (SDSs) and use appropriate personal protective equipment (gloves, gowns, eye protection, and so on). To obtain SDSs, see the “Documentation and Support” section in this document.
-

Symbols on this instrument



Symbols may be found on the instrument to warn against potential hazards or convey important safety information. In this document, the hazard symbol is used along with one of the following user attention words:

- **CAUTION!** – Indicates a potentially hazardous situation that, if not avoided, may result in minor or moderate injury. It may also be used to alert against unsafe practices.
- **WARNING!** – Indicates a potentially hazardous situation that, if not avoided, could result in death or serious injury.
- **DANGER!** – Indicates an imminently hazardous situation that, if not avoided, will result in death or serious injury.

Symbol	English	Français
	Caution, risk of danger Consult the manual for further safety information.	Attention, risque de danger Consulter le manuel pour d'autres renseignements de sécurité.
	Moving parts	Parties mobiles
	Caution, hot surface	Attention, surface chaude
	On	On (marche)
	Off	Off (arrêt)
	Protective conductor terminal (main ground)	Borne de conducteur de protection (mise à la terre principale)

Symbol	English	Français
	<p>Do not dispose of this product in unsorted municipal waste</p> <p> CAUTION! To minimize negative environmental impact from disposal of electronic waste, do not dispose of electronic waste in unsorted municipal waste. Follow local municipal waste ordinances for proper disposal provision and contact customer service for information about responsible disposal options.</p>	<p>Ne pas éliminer ce produit avec les déchets usuels non soumis au tri sélectif.</p> <p> MISE EN GARDE ! Pour minimiser les conséquences négatives sur l'environnement à la suite de l'élimination de déchets électroniques, ne pas éliminer ce déchet électronique avec les déchets usuels non soumis au tri sélectif. Se conformer aux ordonnances locales sur les déchets municipaux pour les dispositions d'élimination et communiquer avec le service à la clientèle pour des renseignements sur les options d'élimination responsable.</p>





Conformity symbols

Conformity mark	Description
	Indicates conformity with safety requirements for Canada and U.S.A.
	Indicates conformity with European Union requirements for safety and electromagnetic compatibility.
	Indicates conformity with Australian standards for electromagnetic compatibility.



Safety alerts on this instrument

Additional text may be used with one of the symbols described above when more specific information is needed to avoid exposure to a hazard. See the following table for safety alerts found on the instrument.

English	Français
 CAUTION! Hazardous chemicals. Read the Safety Data Sheets (SDSs) before handling.	 MISE EN GARDE ! Produits chimiques dangereux. Lire les fiches signalétiques (FS) avant de manipuler les produits.
 CAUTION! Hazardous waste. Refer to SDS(s) and local regulations for handling and disposal.	 MISE EN GARDE ! Déchets dangereux. Lire les fiches signalétiques (FS) et la réglementation locale associées à la manipulation et à l'élimination des déchets.

Location of safety labels on the instrument

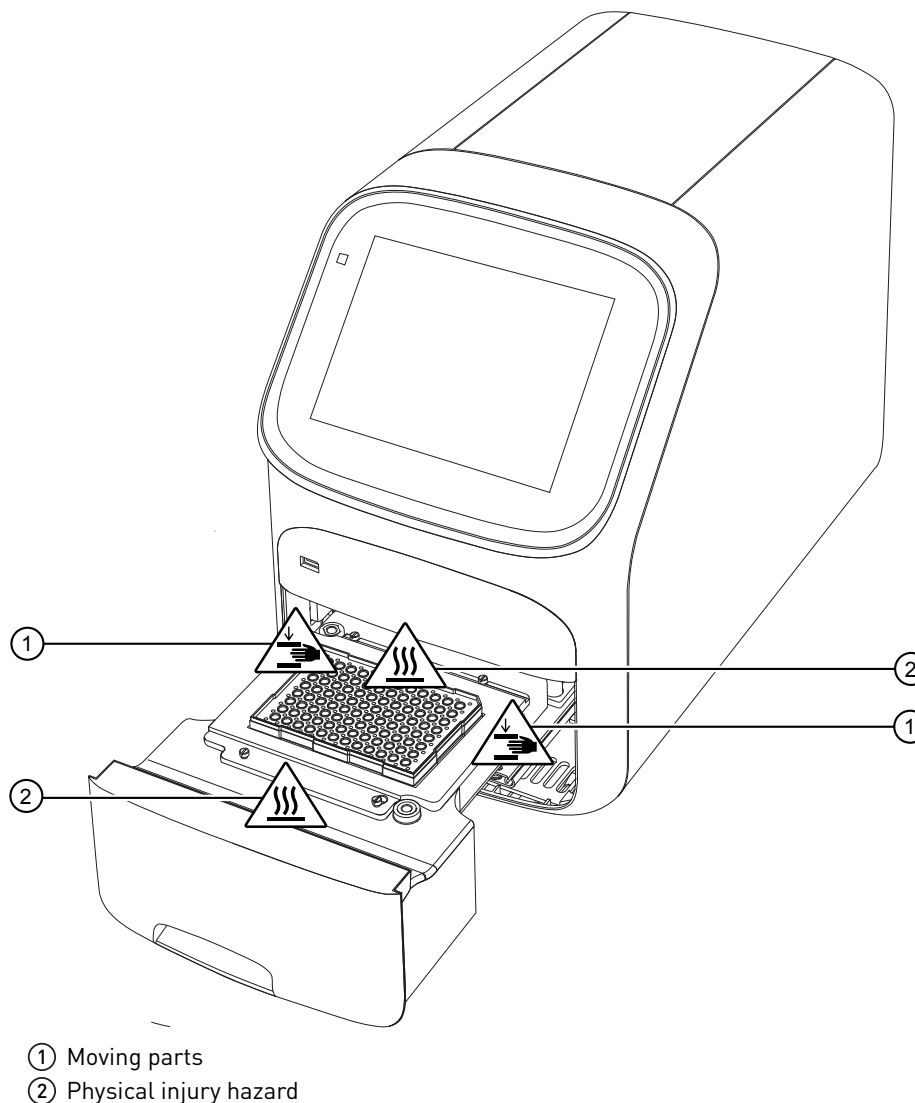

Safety information for instruments not manufactured by Thermo Fisher Scientific

Some of the accessories provided as part of the instrument system are not designed or built by Thermo Fisher Scientific. Consult the manufacturer's documentation for the information needed for the safe use of these products.

Instrument safety

General

 **CAUTION! Do not remove instrument protective covers.** If you remove the protective instrument panels or disable interlock devices, you may be exposed to serious hazards including, but not limited to, severe electrical shock, laser exposure, crushing, or chemical exposure.



Physical injury



CAUTION! Moving Parts. Moving parts can crush, pinch and cut. Keep hands clear of moving parts while operating the instrument. Disconnect power before servicing.



WARNING! Do not attempt to lift or move the instrument without the assistance of others. Use appropriate moving equipment and proper lifting technique, improper lifting may result in serious injury.

Electrical safety



WARNING! Ensure appropriate electrical supply. For safe operation of the instrument:

- Plug the system into a properly grounded receptacle with adequate current capacity.
 - Ensure the electrical supply is of suitable voltage.
 - Never operate the instrument with the ground disconnected. Grounding continuity is required for safe operation of the instrument.
-



WARNING! Power Supply Line Cords. Use properly configured and approved line cords for the power supply in your facility.



WARNING! Disconnecting Power. To fully disconnect power either detach or unplug the power cord, positioning the instrument such that the power cord is accessible.

Cleaning and decontamination



CAUTION! Cleaning and Decontamination. Use only the cleaning and decontamination methods specified in the manufacturer's user documentation. It is the responsibility of the operator (or other responsible person) to ensure the following requirements are met:

- No decontamination or cleaning agents are used that could cause a HAZARD as a result of a reaction with parts of the equipment or with material contained in the equipment.
 - The instrument is properly decontaminated a) if hazardous material is spilled onto or into the equipment, and/or b) prior to having the instrument serviced at your facility or sending the instrument for repair, maintenance, trade-in, disposal, or termination of a loan (decontamination forms may be requested from customer service).
 - Before using any cleaning or decontamination methods (except those recommended by the manufacturer), users should confirm with the manufacturer that the proposed method will not damage the equipment.
-

Safety and electromagnetic compatibility (EMC) standards

The instrument design and manufacture complies with the standards and requirements for safety and electromagnetic compatibility as noted in the following table:



Safety compliance

Reference	Description
EU Directive 2014/35/EU	European Union “Low Voltage Directive”
IEC 61010-1 EN 61010-1 UL 61010-1 CSA C22.2 No. 61010-1	<i>Safety requirements for electrical equipment for measurement, control, and laboratory use – Part 1: General requirements</i>
IEC 61010-2-010 EN 61010-2-010	<i>Safety requirements for electrical equipment for measurement, control and laboratory use – Part 2-010: Particular requirements for laboratory equipment for the heating of materials</i>
IEC 61010-2-081 EN 61010-2-081	<i>Safety requirements for electrical equipment for measurement, control and laboratory use – Part 2-081: Particular requirements for automatic and semi-automatic laboratory equipment for analysis and other purposes</i>

EMC

Reference	Description
Directive 2014/30/EU	European Union “EMC Directive”
EN 61326-1/ IEC 61326-1	<i>Electrical Equipment for Measurement, Control and Laboratory Use – EMC Requirements – Part 1: General Requirements</i>
AS/NZS CISPR 11	<i>Limits and Methods of Measurement of Electromagnetic Disturbance Characteristics of Industrial, Scientific, and Medical (ISM) Radiofrequency Equipment</i>
ICES-001, Issue 4	<i>Industrial, Scientific and Medical (ISM) Radio Frequency Generators</i>
FCC Part 15 Subpart B (47 CFR)	<i>U.S. Standard Radio Frequency Devices</i>

This equipment has been tested and found to comply with the limits for a Class A digital device, pursuant to part 15 of the FCC Rules. These limits are designed to provide reasonable protection against harmful interference when the equipment is operated in a commercial environment. This equipment generates, uses, and can radiate radio frequency energy and, if not installed and used in accordance with the instruction manual, may cause harmful interference to radio communications. Operation of this equipment in a residential area is likely to cause harmful interference in which case the user will be required to correct the interference at his own expense.



Environmental design

Reference	Description
Directive 2012/19/EU	European Union "WEEE Directive" – Waste electrical and electronic equipment
Directive 2011/65/EU	European Union "RoHS Directive" – Restriction of hazardous substances in electrical and electronic equipment
Directive 2006/66/EC	European Union "Battery Directive"

Chemical safety



WARNING! GENERAL CHEMICAL HANDLING. To minimize hazards, ensure laboratory personnel read and practice the general safety guidelines for chemical usage, storage, and waste provided below. Consult the relevant SDS for specific precautions and instructions:

- Read and understand the Safety Data Sheets (SDSs) provided by the chemical manufacturer before you store, handle, or work with any chemicals or hazardous materials. To obtain SDSs, see the "Documentation and Support" section in this document.
- Minimize contact with chemicals. Wear appropriate personal protective equipment when handling chemicals (for example, safety glasses, gloves, or protective clothing).
- Minimize the inhalation of chemicals. Do not leave chemical containers open. Use only with adequate ventilation (for example, fume hood).
- Check regularly for chemical leaks or spills. If a leak or spill occurs, follow the manufacturer's cleanup procedures as recommended in the SDS.
- Handle chemical wastes in a fume hood.
- Ensure use of primary and secondary waste containers. (A primary waste container holds the immediate waste. A secondary container contains spills or leaks from the primary container. Both containers must be compatible with the waste material and meet federal, state, and local requirements for container storage.)
- After emptying a waste container, seal it with the cap provided.
- Characterize (by analysis if necessary) the waste generated by the particular applications, reagents, and substrates used in your laboratory.
- Ensure that the waste is stored, transferred, transported, and disposed of according to all local, state/provincial, and/or national regulations.
- **IMPORTANT!** Radioactive or biohazardous materials may require special handling, and disposal limitations may apply.

Biological hazard safety



WARNING! BIOHAZARD. Biological samples such as tissues, body fluids, infectious agents, and blood of humans and other animals have the potential to transmit infectious diseases. Conduct all work in properly equipped facilities with the appropriate safety equipment (for example, physical containment devices). Safety equipment can also include items for personal protection, such as gloves, coats, gowns, shoe covers, boots, respirators, face shields, safety glasses, or goggles. Individuals should be trained according to applicable regulatory and company/ institution requirements before working with potentially biohazardous materials. Follow all applicable local, state/provincial, and/or national regulations. The following references provide general guidelines when handling biological samples in laboratory environment.

- U.S. Department of Health and Human Services, *Biosafety in Microbiological and Biomedical Laboratories (BMBL)*, 5th Edition, HHS Publication No. (CDC) 21-1112, Revised December 2009; found at:
www.cdc.gov/biosafety/publications/bmb15/BMBL.pdf
 - World Health Organization, *Laboratory Biosafety Manual*, 3rd Edition, WHO/CDS/CSR/LYO/2004.11; found at:
www.who.int/csr/resources/publications/biosafety/Biosafety7.pdf
-

Documentation and support

Related documentation

Document	Publication number
<i>QuantStudio™ 1 Real-Time PCR System Installation, Use, and Maintenance Guide</i>	MAN0017853
<i>QuantStudio™ Design and Analysis Desktop Software Command-Line Application Guide</i>	MAN0010409
<i>QuantStudio™ Design and Analysis Desktop Software User Guide</i>	MAN0010408
<i>QuantStudio™ 1 Real-Time PCR System Site Preparation Guide</i>	MAN0017854

Note: For additional documentation, see “Customer and technical support” on page 102.

Obtain information from the Help system

Customer and technical support

Visit thermofisher.com/support for the latest service and support information.

- Worldwide contact telephone numbers
- Product support information
 - Product FAQs
 - Software, patches, and updates
 - Training for many applications and instruments
- Order and web support
- Product documentation
 - User guides, manuals, and protocols
 - Certificates of Analysis
 - Safety Data Sheets (SDSs; also known as MSDSs)

Note: For SDSs for reagents and chemicals from other manufacturers, contact the manufacturer.

